

DEUTSCHES ELEKTRONEN-SYNCHROTRON

Ein Forschungszentrum der Helmholtz-Gemeinschaft

DESY 19-155

September 2019

Relativity and Aberration

Evgeny Saldin

Deutsches Elektronen-Synchrotron DESY, Hamburg

ISSN 0418-9833

NOTKESTRASSE 85 - 22607 HAMBURG

Relativity and Aberration

Evgeny Saldin ^a

^a*Deutsches Elektronen-Synchrotron (DESY), Hamburg, Germany*

Abstract

The established way of looking at special relativity is based on Einstein postulates: the principle of relativity and the constancy of the velocity of light. In the most general geometric approach to the theory of special relativity, the principle of relativity, in contrast to Einstein formulation, is only a consequence of the (pseudo-Euclidean) geometry of space-time. The space-time geometric approach deals with all possible choices of coordinates (clock synchronization conventions) of the chosen reference frames. In previous papers, we pointed out the very important role that the space-time geometric approach plays in accelerator engineering. The purpose of this paper is to provide a novel insight into the problem of aberration of light based on the space-time geometric approach. We will investigate the case of a plane-polarized light wave reflected from mirrors moving tangentially to its surface. This is a complex phenomenon. It is generally believed that there is no aberration (deviation of the energy transport) for light reflected from mirrors moving transversely (also for light transmitted through a hole in the moving opaque screen or, consequently, through a moving open end of the telescope barrel). We show that this typical textbook statement is incorrect. The aberration of starlight seems to be one of the simplest phenomena of astronomical observations. However, the story of misunderstanding is long and lasts till now. Scientific papers and textbooks on relativity state or imply that stellar aberration is determined by the relative velocity between the star and observer on the earth. Observations show clearly that stellar aberration does not depend on the relative motion between the star and the telescope on the earth but exists only when the telescope is moving. There is no known explanation for the case when the star is moving. The lack of symmetry, between the cases when either the source or detector is moving is shown clearly on the basis of the separation of binary stars. One can reliably determine the motion of individual stars of a binary system from their spectrum, from a periodic Doppler shifting of the spectral lines of the star components. Such aberration is not observed. Some authors use this fact to argue that stellar aberration contradicts the special theory of relativity. We have shown that the fact that we do not see myriads of widely separated binaries in wild gyration does not require any fundamental change of outlook, but it does require that aberration of "distant" stars should be treated in the framework of space-time geometric approach.

1 Introduction

1.1 *Different approaches to special relativity*

The established way of looking at special relativity is based on Einstein's postulates: (i) the principle of relativity and (ii) the constancy of the velocity of light. Accepting the postulate on the constancy of the speed of light in all inertial frames we also automatically assume Lorentz coordinates and the fact that different inertial frames are related by Lorentz transformations. In other words, according to such limiting understanding of the theory of relativity, it is assumed that only Lorentz transformations must be used to map the coordinates of events between inertial observers. However, the constancy of the light velocity in all inertial systems of reference is not a fundamental statement of the theory of relativity. The central principle of special relativity is the Lorentz covariance of all the fundamental laws of physics. It is important to stress at this point that the second postulate, contrary to the view presented in textbooks, is not a separate physical assumption, but a convention that cannot be the subject of experimental tests.

In the most general space-time geometric approach to the theory of special relativity, the principle of relativity, in contrast to Einstein's formulation of the special relativity, is only a consequence of the (pseudo-Euclidean) geometry of space-time. The space-time continuum can be described in arbitrary coordinates. By changing these arbitrary coordinates, the geometry of the four-dimensional space-time obviously does not change, and in the special theory of relativity we are not limited in any way in the choice of a coordinates system. The space coordinates x^1, x^2, x^3 can be any quantities defining the position of particles in space, and the time coordinate t can be defined by an arbitrary running clock. Since the space-time geometric approach deals with all possible choices of coordinates of the chosen reference frames, the second Einstein postulate referred to the constancy of the coordinate velocity of light does not hold in this formulation of the theory of relativity. Only in Lorentz coordinates, when Einstein's synchronization of distant clocks and Cartesian space coordinates are used, the coordinate speed of light is isotropic and constant. Thus the basic elements of the space-time geometric formulation of the special relativity and the usual Einstein's formulation, are quite different.

Conventional textbook presentations of the special theory of relativity use Einstein's approach or, as a generalization, the usual covariant approach which deals only with components of the 4-tensors in specific (orthogonal) Lorentz basis. The fact that in the process of transition to arbitrary coordinates the geometry of the space-time does not change, is not considered

in textbooks. As a consequence, there is a widespread belief among experts that a Galilean transformation (which is actually a transformation from an orthogonal Lorentz basis to a non-orthogonal basis) is incorrect, while a Lorentz transformation (which is a transformation from an orthogonal Lorentz basis to another orthogonal Lorentz basis) is correct. This is not true. We can describe physics in any arbitrary coordinates system. Although Einstein synchronization, which is equivalent to Lorentz coordinates choice, is preferred by physicists due to its simplicity and symmetry, it is nothing more "physical" than any other. A particular, very unusual choice of coordinates, the absolute time coordinate choice, will be considered and exploited in this paper.

In previous papers [1–3] we pointed out the very important role that the space-time geometric approach plays in the relativistic engineering. The space-time geometric approach to special relativity deals with all possible choices of coordinates (clock synchronization conventions) of the chosen reference frames. We must emphasize that in accelerator physics there are two choices of clock synchronization convention useful to consider:

- (a) Einstein's convention, leading to the Lorentz transformations between frames.
- (b) Absolute time convention, leading to the Galilean transformations between frames.

Absolute time (or simultaneity) can be introduced in special relativity without affecting neither the logical structure, nor the (convention-independent) predictions of the theory. Actually, it is just a simple effect related to a particular parametrization. In the theory of relativity, this choice may seem quite unusual, but it is usually most convenient when one wants to connect to laboratory reality. As a matter of fact, the absolute time synchronization is not artificial: the accelerator physicists constantly use it as a hidden assumption in their conventional particle tracking codes.

According to usual accelerator engineering, the study of relativistic particle motion in a constant magnetic field is intimately connected with the old (Newtonian) kinematics: the Galilean vectorial law of addition of velocities is actually used. However, Maxwell's equations are not covariant under Galilean transformations. We cannot take one kinematics for one part of physical phenomena and the other kinematics for the other, namely Galilean transformations for mechanics and Lorentz transformations for electrodynamics. We must decide which part must be retained and which must be modified.

We demonstrated in [1–3] that there is no principle difficulty with the non-covariant approach in mechanics and electrodynamics. It is perfectly satis-

factory. It does not matter which transformation is used to describe the same reality. What matters is that once fixed, such convention should be applied and kept consistently in both dynamics and electrodynamics. The common mistake made in accelerator physics is connected with the incorrect algorithm for solving the electromagnetic field equations. If one wants to use the usual Maxwell's equations, only the solution of the dynamics equations in the covariant form (i.e. in Lorentz coordinates) gives the correct coupling between Maxwell's equations and particle trajectories in the lab frame.

1.2 *Aberration of light. Geometry and approximations*

We are now in the position to understand a number of interesting optical phenomena in the framework of the electromagnetic field theory, based on the use of the four-geometrical approach. For example, consider the effect of light aberration, which is a change in the direction of light propagation ascribed to boosted light sources. Light, being a special case of electromagnetic waves, is described by the electrodynamics theory. It is well known that the electrodynamics theory meets all requirements of the theory of relativity and therefore must accurately describe the properties of such a typical relativistic object as light.

We will describe the effect of aberration of light by working only up to the first order v/c . The appearance of relativistic effects in radiation phenomena does not depend on a large speed of the radiation sources. Lorentz transformations always give rise to relativistic kinematics and no matter how small the ratio v/c may be.

There is a realistic configuration encountered in practice, which involves the production of dipole radiation. Let us consider the case when a dipole light source in the lab frame is accelerated from rest up to velocity v along the x -axis. Consider the effect of light aberration, that is a change in the direction of light propagation ascribed to boosted light sources. The explanation of the effect of aberration of light presented in well-known textbooks is actually based on the use of a Lorentz boost (i.e. of relativistic kinematics) to describe how the direction of a beam of light depends on the velocity of the light source relative to the lab frame.

Let us discuss the special case of aberration of a vertical beam of light. Suppose that a light source, studied in the comoving frame S' , radiates a plane wave along the z' -axis. As a simple model of a plane-wave emitter, we use a two-dimensional array of identical coherent elementary sources (dipoles), uniformly distributed on a given $(x' - y')$ plane P . We take the elementary sources to start radiating waves simultaneously with respect

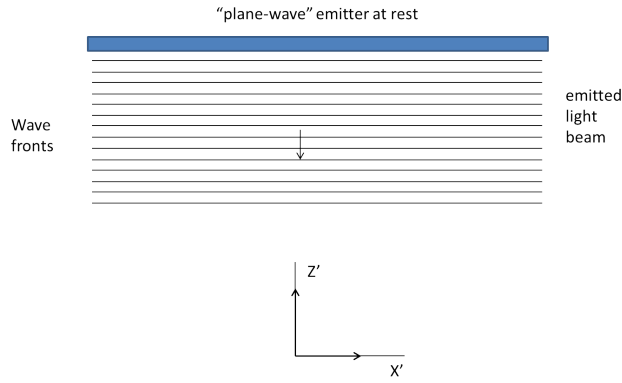

Fig. 1. Light source, studied in the comoving frame S' , radiates a plane wave along the z' axis.

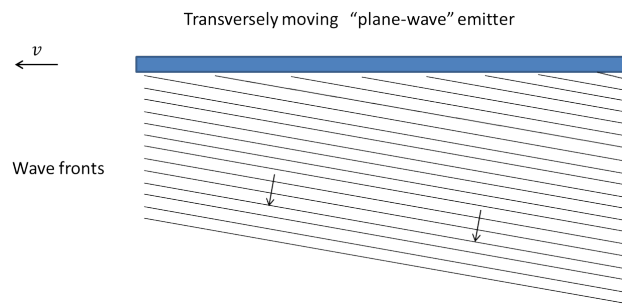

Fig. 2. Transversely moving a "plane-wave" emitter. The explanation of the effect of aberration is based on the use of a Lorentz boost to describe how the direction of a light beam depends on the velocity of light source relative to the lab frame. If make a Lorentz boost, we automatically introduce a time transformation $t' = t - xv/c^2$ and the effect of this transformation is just a rotation of the radiation phase front in the lab frame.

to the reference frame S' where the plane P is at rest. So we have a plane full of sources, oscillating together, with their motion in the plane and all having the same amplitude and phase. Let us suppose that the elementary sources are oscillating at frequency ω . By letting the distance between each two adjacent elementary sources approach zero (i.e. much smaller with respect to the radiation wavelength $\lambda = 2\pi c/\omega$), we may consider this two-dimensional arrangement as an ideal plane-wave emitter.

Fig. 1 depicts a special case of "plane-wave" emitter. This emitter in the comoving frame S' will radiate plane wavefront in a vertical direction. Now imagine what happens in the lab frame S , where the emitter is moving with constant speed v along the x -axis of a Cartesian (x, y, z) system (taken to be parallel to the axes of the comoving frame). The transformation of observations from the lab frame with Lorentz coordinates to the comoving Lorentz frame is described by a Lorentz boost. We will describe the effect of aberration of light by working only up to the first order v/c . On the one hand, the wave equation remains invariant with respect to Lorentz transformations.

On the other hand, if we make a Lorentz boost, we automatically introduce a time transformation $t' = t - xv/c^2$ and the effect of this transformation is just a rotation of the radiation phase front in the lab frame, Fig.2. This is because the effect of this time transformation is just a dislocation in the timing of processes, which has the effect of rotating the plane of simultaneity on the angle v/c in the first-order approximation. Due to the motion of the emitter, the elementary sources along the emitter will not radiate simultaneously. As a consequence of this simultaneity loss, there will exist a certain non-zero time interval between the beginning of the emission of any two elementary sources on the emitter, and this time interval will depend on the distance between the sources.

In other words, when a uniform translational motion of the source is treated according to Lorentz transformations, the aberration of light effect is described in the language of relativistic kinematics. In fact, the relativity of simultaneity is a relativistic effect that appears also in the first order in v/c .

1.3 *Aberration effect from transversely moving mirror*

In this paper, we present a critical reexamination of the existing aberration of light theory. We will investigate the case of a plane-polarized light wave reflected from mirrors moving transversely. Aberration for light reflected from a moving mirror is a complex phenomenon. It is generally believed that there is no aberration for light reflected from mirrors moving transversely. To quote e.g. Sommerfeld [8]: "Thus, for a mirror moving tangentially to its surface the law of reflection which holds for the stationary mirror is preserved." We use the four-geometrical arguments to show that this typical textbook statement is incorrect.

First, we examine the reasoning presented in textbooks. The authors analyze the reflection in two Lorentz reference frames. The fixed (lab) frame K is at rest with respect to the plane-wave emitter. The moving frame K' has velocity v . In this frame, the mirror is at rest. In both frames, we use a Cartesian coordinate system in which $x - y$ plane is tangent to the reflection surface. The x direction coincides with the direction of v . For simplicity, we consider the case in which light is incident from the z direction in the lab frame. Incident light is described by its four-dimensional wave vector whose time like component is the angular frequency ω and whose space like components define the direction of propagation. In the lab frame, (t, x, y, z) , this vector has components $k_1 = (\omega, 0, 0, -\omega/c)$, where the negative sign indicates propagation toward the mirror (Fig. 3a). Our task is to determine the wave vector for the reflected beam.

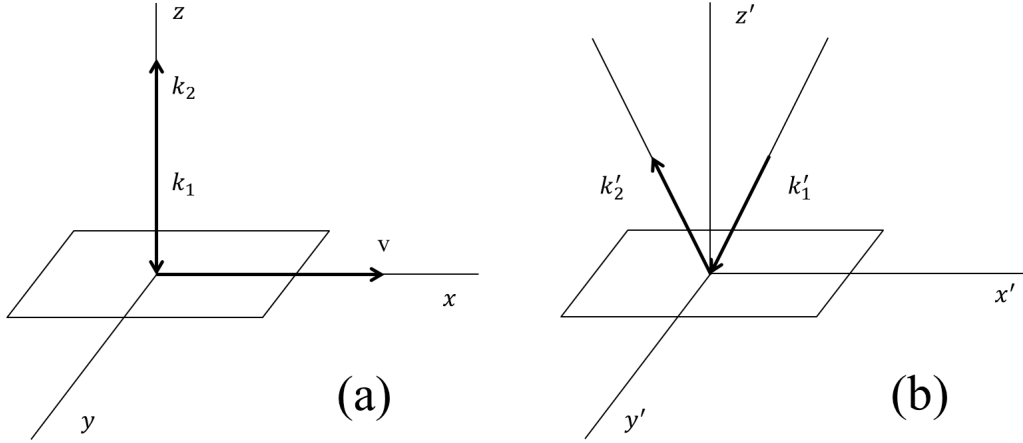

Fig. 3. The aberration of light effect is described in the language of relativistic kinematics of wavenumber four vector. Geometry of the reflection as seen from (a) lab frame, (b) inertial frame moving with the same velocity as the mirror. According to textbooks (see e.g. [8]), there is no aberration for light reflected from tangentially moving mirror.

The argument that there is no aberration for light reflected from tangentially moving mirror runs something like this. It is easiest to consider the reflection in the moving frame (Fig. 3b). In this frame, the surface is at rest, so the usual laws of optical reflection apply. We will describe the effect of aberration of light by working only up to the first order v/c . An observer moving with the mirror's surface sees the wave vector $k'_1 = (\omega, -v\omega/c^2, 0, -\omega/c)$. The effect of reflection is to reverse the sign of the z' component of the wave vector, $k'_2 = (\omega, -v\omega/c^2, 0, \omega/c)$. We now obtain the reflected wave vector in the lab frame by applying the inverse Lorentz transformation: $k_2 = (\omega, 0, 0, \omega/c)$. This vector represents a light beam traveling away from the mirror, having the same frequency as the incoming beam. This shows that the beam is reflected according to the usual geometrical optics laws, and the beam suffers no aberration.

The peculiarity of this kinematic consequence of the Lorentz transformation is that here the emitter of the plane wave is at rest in the lab frame and the reflector is moving with the constant speed with respect to the lab frame. The authors of textbooks got the incorrect result by using an incorrect physical argument. This wrong argument is an assumption about common Lorentz time coordinate in the lab frame for both mirror and emitter. The question now arises how to assign a time coordinate in the lab reference frame ¹.

¹ When the "plane-wave" emitter and mirror moving at constant velocity relative to the laboratory observer the setup (from electrodynamics point of view) is equivalent to the well-known light clock setup and an assumption about common Lorentz time coordinate is correct.

As was shown in [1–3], we can prepare for mirror and emitter common set of synchronized clocks in the lab frame only in the case of the absolute time coordinatization i.e in the case when simultaneity is absolute. In this paper, we will investigate in detail the reason why this is the case. Thus the misconception regarding the aberration of light from the transversely moving mirror is a consequence of the pseudo-Euclidean geometry of four-dimensional space-time manifold.

1.4 Difficulties in understanding

There is a widespread view that only philosophers of physics discuss the issue of distant clock synchronization. Indeed, a typical physical laboratory contains no space-time grid. It should be clear that a rule-clock structure exists only in our mind and manipulations with non-existing clocks in the special relativity are an indispensable prerequisite for the application of dynamics and electrodynamics theory in the coordinate representation. Such a situation usually forces physicists to believe that the application of the theory of relativity to the study of physical processes is possible without detailed knowledge of the clocks synchronization procedure.

In Section 2 we discuss an "operational interpretation" of the Lorentz and absolute time coordinatizations. This is probably the most important and complicated section of our paper. The difference between absolute time synchronization and Einstein's time synchronization from the operational point of view will be an important discovery for every special relativity expert. To our knowledge, neither operational interpretation of the absolute time coordinatization nor the difference between absolute time synchronization and Einstein's time synchronization from the operational point of view, are given elsewhere in the literature. An analysis of the reason why authors of famous textbooks obtained an incorrect result for the aberration of light from the transversely moving mirror is the focus of this section. As we will show, the mistake of the authors is not computational but conceptual in nature. The common (for mirror and emitter) Lorentz frame cannot be realized in the case of relative velocity between the emitter and the mirror.

Many physicists, who have not had further training in theoretical physics, find that Section 2 is a rather long and abstract side tour. They can skip over it, and come back later if they are interested. For such readers, we would like to summarize the results of our theory of the aberration of light in the simplified form that will be useful for their later work.

The central result of this paper is that we have shown that the authors of textbooks overlooked the influence of the Doppler effect. Indeed, we

demonstrated that the Doppler effect, in this case, results directly from the time-dependence of the transverse position of the moving mirror with finite aperture. What must be recognized is that in the time-dependent emitter-mirror problem, the solution makes reference to the light beams with different frequencies. The results will depend on the direction of the velocity vector. If we may assume that terms of the second order are below the accuracy of the experiment we can neglect the influence of the Doppler effect on the frequency changes. But what was overlooked is that for transversely moving mirror we cannot neglect the angular frequency dispersion which is the effect at first order in v/c . When one has a transversely moving mirror and a plane wave of light is falling normally on the mirror, there is the deviation of the energy transport for light reflected from the mirror. This effect is a consequence of the fact that the Doppler effect is responsible for the angular frequency dispersion of the light waves reflected from the mirror. As a result, the velocity of the energy transport is not equal to the phase velocity.

According to the Babinet's principle, this remarkable prediction of our theory is correct also for light transmitted through a hole in the moving opaque screen or, consequently, through a moving open end of the telescope barrel.

1.5 *Stellar aberration*

The exact position where a star appears in the sky does not only depends on the coordinates of the source observed, but also on the observer's relative velocity. The observer velocity is responsible for a phenomenon called "Bradly aberration" or "Stellar aberration". It was discovered by the astronomer Bradley in 1727.

It is widely believed that stellar aberration, like the stellar Doppler effect, depends on the relative velocity of the source (star) and observer. In the paper on the theory of relativity Einstein deduced the aberration formula from the idea that the velocity of v is the relative velocity of the star-earth system. The idea was represented by many authors of textbooks.

To quote Moeller [5]: "This phenomenon, which is called aberration, was observed in 1727 by Bradley who noticed that the stars seem to perform a collective annual motion in the sky. This apparent motion is simply due to the fact that the observed direction of a light ray coming from a star depends on the velocity of the earth relative to the star."

However, it has been demonstrated that observations are not compatible with those predictions. In 1950 Ives [6] stressed for the first time that the presence of binaries in the sky gave rise to an important difficulty for the

theory of relativity. It is stated that the idea that aberration may be described in terms of relative motions of the bodies concerned is immediately refuted by the existence of spectroscopic binaries with velocities comparable with that of the Earth in its orbit. Still this exhibit aberrations not different from other stars. For example, a spectroscopic binary, Mizar A, has well-known orbital parameters, from which can be calculated an observable angular separation of $1'10''$ if aberration were due to relative velocity. The empirical value is less than $0.01''$, clearly incompatible with authors of textbooks point of view [7,8]. There is no available explanation for the fact that, while the observational data on stellar aberration are compatible with moving earth, the symmetric description, when the star possesses the relative transverse motion, does not apparently lead to observations compatible with predictions.

The effect of stellar aberration seems to be one of the simplest phenomena in astronomical observations. But there is a large literature about it betraying a problem of asymmetry between observer and source motion. Some authors use this fact to argue that stellar aberration contradicts the special theory of relativity. In order to find correct and rational (relativistic) explanation for the observed absence of aberration produced by the motion of source, the mechanism of stellar aberration should be reviewed.

It is generally believed that "The familiar analogy of the starlight aberration phenomenon is to a tall, upwardly pointing hat used to catch rain in a vertical rain shower by a runner running through it. The hat must be tilted if the rain is to pass through the opening of the hat to wet the bottom." [9]. This "raindrop" model presented in most published papers and textbooks is incorrect and misleading. We present a wave optics-based theory for the aberration of starlight and demonstrate that there exists the deviation of the energy transport in the case of moving open end of the telescope barrel. The difficulty is resolved by noting that when the light passes through the end of telescope barrel we have a light beam whose fields have been perturbed by diffraction, and now not include information about emitter motion. The stellar aberration is considered independent of the source speed and to have just a local origin exclusively based on the observer speed.

2 Aberration of light problem in the coordinatized description

2.1 Operational interpretation of the Lorentz coordinatizations

2.1.1 Dipole source is at rest

Let us give an "operational interpretation" of the Lorentz coordinatizations. The fundamental laws of electrodynamics are expressed by Maxwell's equations, according to which, as well-known, light propagates with the same velocity c in all directions. This is because Maxwell's theory has no intrinsic anisotropy. It has been stated that in their original form Maxwell's equations are only valid in inertial frames. However, Maxwell's equations can be written down in coordinate representation only if the space-time coordinate system has already been specified.

We would like to start with the question of how to assign space-time coordinates to an inertial frame, where a source of light is at rest. We need to give a "practical", "operational" answer to this question. The most natural method of synchronization consists in putting all the ideal clocks together at the same point in space, where they can be synchronized. Then, they can be transported slowly to their original places (slow clock transport) [10].

The usual Maxwell's equations are valid in any inertial frame where sources are at rest and the procedure of slow clock transport is used to assign values to the time coordinate. The same considerations apply when charged particles are moving in a non-relativistic manner. In particular, when oscillating, charged particles emit radiation, and in the non-relativistic case, when charges oscillate with velocities much smaller than c , dipole radiation is generated and described with the help of Maxwell's equations in their usual form.

The theory of relativity offers an alternative procedure of clocks synchronization based on the constancy of the speed of light in all inertial frames. This is usually considered a postulate but, as we have seen, it is just a convention. The synchronization procedure that follows is the usual Einstein synchronization procedure. Suppose we have a dipole radiation source. When the dipole light source is at rest, the field equations are constituted by the usual Maxwell's equations. Indeed, in dipole radiation theory we consider the small expansion parameter $v/c \ll 1$ neglecting terms of order v/c . In other words, in dipole radiation theory we use zero order non-relativistic approximation². Einstein synchronization is defined in terms of light sig-

² The retardation time in the integrands of the expression for the radiation field amplitude, can be neglected in the cases where the trajectory of the charge changes

nals emitted by the dipole source at rest, assuming that light propagates with the same velocity c in all directions. Using the Einstein synchronization procedure in the rest frame of the dipole source, we actually select the Lorentz coordinate system.

Slow transport synchronization is equivalent to Einstein synchronization in the inertial system where the dipole light source is at rest. In other words, suppose we have two sets of synchronized clocks spaced along the x axis. Suppose that one set of clocks is synchronized by using the slow clock transport procedure and the other by light signals. If we would ride together with any clock in either set, we could see that it has the same time as the adjacent clocks, with which its reading is compared. This is because in our case of interest, when a light source is at rest, field equations are the usual Maxwell's equations and Einstein synchronization is defined in terms of light signals emitted by a source at rest assuming that light propagates with the same velocity c in all directions. Using any of these synchronization procedures in the rest frame we actually select a Lorentz coordinate system. In this coordinate system the metric has Minkowski form $ds^2 = c^2 dt'^2 - dx'^2 - dy'^2 - dz'^2$. In the rest frame, fields are expressed as a function of the independent variables x', y', z' , and t' . Let us consider Maxwell's equations in free space. The electric field \vec{E}' of an electromagnetic wave satisfies the equation $\square'^2 \vec{E}' = \nabla'^2 \vec{E}' - \partial^2 \vec{E}' / \partial (ct')^2 = 0$.

2.1.2 A moving dipole source

We now consider the case when the light source in the lab frame is accelerated from rest up to velocity v along the x -axis. A fundamental question to ask is whether our lab clock synchronization method depends on the state of motion of the light source or not. The answer simply fixes a convention. The simplest method of synchronization consists in keeping, without changes, the same set of uniformly synchronized clocks used in the case when the light source was at rest, i.e. we still enforce the clock transport synchronization (or Einstein synchronization which is defined in terms of light signals emitted by the dipole source at rest). This choice is usually the most convenient one from the viewpoint of connection to laboratory reality.

This synchronization convention preserves simultaneity and is actually based on the absolute time (or absolute simultaneity) convention. After

little during this time. It is easy to find the conditions for satisfying this requirement. Let us denote by a the order of magnitude the dimensions of the system. Then the retardation time $\sim a/c$. In order to ensure that the distribution of the charges in the system does not undergo a significant change during this time, it is necessary that $a \ll \lambda$, where λ is the radiation wavelength. In accounting only for the dipole part of the radiation we neglect all information about the electron trajectory.

the boost along the x axis, the Cartesian coordinates of the emitter transform as $x' = x - vt$, $y' = y$, $z' = z$. This transformation completes with the invariance of simultaneity, $\Delta t' = \Delta t$. The absolute character of the temporal coincidence of two events is a consequence of the absolute concept of time, enforced by $t' = t$. As a result of the boost, the transformation of time and spatial coordinates of any event has the form of a Galilean transformation.

In the comoving frame, fields are expressed as a function of the independent variables x', y', z' , and t' . According to the principle of relativity, Maxwell's equations always valid in the Lorentz comoving frame. The electric field \vec{E}' of an electromagnetic wave satisfies the equation $\square'^2 \vec{E}' = \nabla'^2 \vec{E}' - \partial^2 \vec{E}' / \partial (ct')^2 = 0$. However, the variables x', y', z', t' can be expressed in terms of the independent variables x, y, z, t by means of a Galilean transformation, so that fields can be written in terms of x, y, z, t . From the Galilean transformation $x' = x - vt$, $y' = y$, $z' = z$, $t' = t$, after partial differentiation, one obtains $\partial / \partial t = \partial / \partial t' - v \partial / \partial x'$, $\partial / \partial x = \partial / \partial x'$. Hence the wave equation transforms into

$$\square^2 \vec{E} = \left(1 - \frac{v^2}{c^2}\right) \frac{\partial^2 \vec{E}}{\partial x^2} - 2 \left(\frac{v}{c}\right) \frac{\partial^2 \vec{E}}{\partial t \partial x} + \frac{\partial^2 \vec{E}}{\partial y^2} + \frac{\partial^2 \vec{E}}{\partial z^2} - \frac{1}{c^2} \frac{\partial^2 \vec{E}}{\partial t^2} = 0, \quad (1)$$

where coordinates and time are transformed according to a Galilean transformation.

After properly transforming the d'Alembertian through a Galileo boost, which changes the initial coordinates (x', y', z', t') into (x, y, z, t) , we can see that the homogeneous wave equation for the field in the lab frame has nearly but not quite the usual, standard form that takes when there is no uniform translation in the transverse direction with velocity v . The main difference consists in the crossed term $\partial^2 / \partial t \partial x$, which complicates the solution of the equation. To get around this difficulty, we observe that simplification is always possible. The trick needed here is to further make a change of the time variable according to the transformation $t' = t - xv_x / c^2$. In the new variables in i.e. after the Galilean coordinate transformation and the time shift we obtain the d'Alembertian in the following form

$$\square^2 = \left(1 - \frac{v_x^2}{c^2}\right) \frac{\partial^2}{\partial x^2} + \frac{\partial^2}{\partial y^2} + \frac{\partial^2}{\partial z^2} - \left(1 - \frac{v_x^2}{c^2}\right) \frac{1}{c^2} \frac{\partial^2}{\partial t^2}. \quad (2)$$

A further change of a factor γ in the scale of time and the coordinate along the direction of uniform motion leads to the usual wave equation.

We have, then, a general method for finding a solution of electrodynamics

problem in the case of the absolute time coordinatization. Since the Galilean transformation $x = x' + vt'$, $t = t'$, completed by the introduction of the new variables $ct_n = \left[\sqrt{1 - v^2/c^2}ct + (v/c)x / \sqrt{1 - v^2/c^2} \right]$, and $x_n = x / \sqrt{1 - v^2/c^2}$, is mathematically equivalent to a Lorentz transformation $x_n = \gamma(x' + vt')$, $t_n = \gamma(t' + vx'/c^2)$, it obviously follows that transforming to new variables x_n, t_n leads to the usual Maxwell's equations. In particular, when coordinates and time are transformed according to a Galilean transformation followed by the variable changes specified above, the d'Alembertian $\square'^2 = \nabla'^2 - \partial^2/\partial(ct')^2$ transforms into $\square_n^2 = \nabla_n^2 - \partial^2/\partial(ct_n)^2$. As expected, in the new variables the velocity of light is constant in all directions, and equal to the electrodynamics constant c .

The overall combination of Galileo transformation and variable changes actually yields the Lorentz transformation in the case of absolute time coordinatization in the lab frame, but in this context this transformation is only to be understood as a useful mathematical device, which allows one to solve the electrodynamics problem in the choice of absolute time synchronization with minimal effort.

We can now rise an interesting question: do we need to transform the results of the electrodynamics problem solution into the original variables? We state that the variable changes performed above have no intrinsic meaning - their meaning only being assigned by a convention. In particular, one can see the connection between the time shift $t = t' + x'v/c^2$ and the issue of clock synchrony. Note that the final change in the scale of time and spatial coordinates is unrecognizable also from a physical viewpoint. It is clear that the convention-independent results of calculations are precisely the same in the new variables. As a consequence, we should not care to transform the results of the electrodynamics problem solution into the original variables.

The question now arises on how to operationally interpret these variable changes i.e. how one should change the rule-clock structure of the lab reference frame. In order to assign a Lorentz coordinate system in the lab frame after the Galilean boost $x = x' + vt'$, $t = t'$, one needs to perform additionally a change scale of reference rules $x \rightarrow \gamma x$, accounting for length contraction. After this, one needs to change the rhythm of all clocks $t \rightarrow t/\gamma$, thus accounting for time dilation. The transformation of the rule-clock structure completes with the distant clock resynchronization $t \rightarrow t + xv/c^2$. This new space-time coordinates in the lab frame are interpreted, mathematically, by saying that the d'Alembertian is now diagonal and the speed of light from the moving source is isotropic and equal to c .

2.1.3 *Two dipole sources with different velocities*

Consider now two light sources say "1" and "2". Suppose that in the lab frame the velocities of "1" and "2" are \vec{v}_1, \vec{v}_2 and $\vec{v}_1 \neq \vec{v}_2$. The question now arises how to assign a time coordinate to the lab reference frame. We have a choice between an absolute time coordinate and a Lorentz time coordinate. The most natural choice, from the point of view of connecting to the laboratory reality, is the absolute time synchronization. In this case simultaneity is absolute, and for this we should prepare, for two sources, only one set of synchronized clocks in the lab frame. On the other hand, Maxwell's equations are not form-invariant under Galilean transformations, that is, their form is different on the lab frame. In fact, the use of the absolute time convention, implies the use of much more complicated field equations, and these equations are different for each source. Now we are in the position to assign Lorentz coordinates. The only possibility to introduce Lorentz coordinates in this situation consists in introducing individual coordinate systems (i.e. an individual set of clocks) for each source. It is clear that if operational methods are at hand to fix the coordinates (clock synchronization in the lab frame) for the first source, the same methods can be used to assign values to the coordinates for the second source and these will be two different Lorentz coordinate systems.

2.2 *The case of a relative velocity between the "plane-wave" emitter and the mirror*

The peculiarity of our case of interest with the viewpoint of relativistic kinematics is that here the emitter of the plane wave is at rest in the lab frame and the mirror is moving with the constant speed with respect to the lab frame. The question now arises how to assign a time coordinate in the lab reference frame where the emitter is at rest. Above we demonstrated that in the case of relative velocity between two individual dipole sources the only possibility to introduce Lorentz coordinates consists in introducing individual coordinate systems for each source. Unfortunately, the case of relative velocity between the emitter and the mirror is significantly more complex than the case of a relative velocity between the two individual dipole sources. Mirror and emitter are entangled (with the viewpoint of electrodynamics) system.

Suppose that we assign the Lorentz time coordinate for the description of the emitter radiation. But this will be the absolute time coordinatization for the boosted mirror and this boost will be described in such coordinatization by the Galilean transformation. Suppose that we resynchronize clocks in the lab frame in order to assign the Lorentz time coordinate for the boosted mirror. In this coordinatization, we describe the reflection of light by a moving

mirror using the usual Maxwell's equations. But this new time coordinate in the lab frame is interpreted by saying that Maxwell's equations are not applicable to the emitter radiation description.

We have only a choice between a Lorentz time coordinate for the emitter and Lorentz time coordinate for the boosted mirror. The most natural choice, from the theoretical point of view, is the Lorentz coordinatization for the plane-wave emitter. In other words, we suppose that in the lab frame (where the plane-wave emitter is at rest) the procedure of slow clock transport is used to assign values to the time coordinate. According to the principle of relativity, usual Maxwell's equations can always be used in any Lorentz frame where the source is at rest. In particular, emitter radiation will be generated and described with the help of Maxwell's equations in their usual form. We now consider the case when the mirror in the lab frame is accelerated from rest up to velocity v along the x -axis. Our method of synchronization consists in keeping, without changes, the same set of uniformly synchronized clocks i.e. we still enforce the clock transport synchronization (or Einstein synchronization which is defined in terms of light signals emitted by the dipole source at rest).

This synchronization convention preserves simultaneity and is actually based on the absolute time (or absolute simultaneity) convention. After the boost along the x axis, the Cartesian coordinates of the mirror transform as $x' = x - vt$, $y' = y$, $z' = z$. This transformation completes with the invariance of simultaneity, $t' = t$. As a result of the boost, the transformation of time and spatial coordinates of any event has the form of a Galilean transformation. Maxwell's equations are not form-invariant under Galilean transformations, that is, their form is different in the lab frame. In particular, mirror radiation will be generated and described with the use of more complicated (anisotropic) field equations.

3 Misunderstanding about aberration of plane waves

The concept of an (infinite) plane wave is widely used in physics. It is an analytically well-behaved solution of Maxwell's equations. However, it is not physically a realizable solution since the total energy content of such a wave is infinite. In spite of this, the concept is useful. Above we already used a model of "plane-wave" emitter in the treatment of the aberration of light phenomenon. We discussed the change in the apparent angular position of a source due to a change in the relative velocity of source and observer. In any physically realizable situation, one will have to consider the finite source aperture. It is assumed that the detector for the direction of radiation is an energy propagation detector and the size of the detector aperture is

sufficiently large compared with the radiation beam size ³ . Indeed, what is usually considered as an aberration is, in fact, an apparent deviation of the energy transport.

However, in dealing with infinite plane waves one will have an incorrect model of aberration from a transversely moving mirror. What authors of textbooks generally overlooked is the fact that the energy transport problem is well-defined only if the source and mirror apertures have already been specified. We try to consider the problem in the most simplified form possible. Rather than starting with a question about the aberration of light in the case of an arbitrary source and mirror apertures, we would like to demonstrate a method that allows us to find the defining characteristics of aberration measurements in the limits of very small and very large aperture mirror. By very small (very large) aperture, we mean that the transverse size of the moving mirror is very small (very large) relative to the transverse size of the "plane-wave" emitter.

4 Analysis of reflection from a mirror moving transversely

4.1 Direction of the energy transport from the lab observer's point of view

4.1.1 Small aperture mirror

We shall now discuss the situation where there is a small aperture mirror moving tangentially to its surface. For simplicity, we shall assume that the transverse size of the moving mirror is very small relative to the transverse size of the "plane-wave" emitter, as sketched in Fig. 4. It is worth noting that we consider an aberration angle that is relatively large compared to the divergence of the reflected radiation. In other words, $\lambda/D_e \ll \lambda/D_m \ll v/c$, where D_e and D_m are the transverse size of the emitter and mirror, respectively.

It is generally believed that for a mirror moving tangentially to its surface the law of reflection which holds for the stationary mirror is preserved, Fig.4. In other words, the velocity of the energy transport is equal to the phase velocity. This statement presented in most textbooks and is incorrect.

The direction of propagation is not always given by the normal to the wave-

³ We do not need to know any more about the detector operation. In this sense, we can discuss in the lab frame (where the detector is at rest) about the radiation beam propagation direction with respect to the lab frame axes and any detail about the detector is not needed.

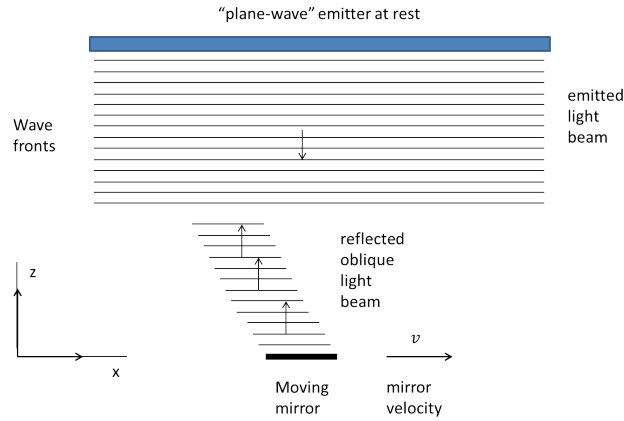

Fig. 4. Transversely moving mirror with small aperture at normal incident. According to textbooks (see e.g. [8]), there is no deviation of the energy transport for the reflected light beam. The monochromatic plane wave of light is falling normally on the moving small aperture mirror and generates a reflected oblique beam.

front ⁴. We must identify the direction of propagation with the direction of energy propagation, supposing the latter to transform differently from the wave normal under the Galilean transformation. There is no aberration for the direction of the phase planes, their normals being always along z axis, but there is the aberration of light for the direction of the beams which is associated with the energy transport. It is well known that in the Lorentz coordinate system the phase planes of light are always perpendicular to the direction of transport. This does not happen for other coordinatizations (for instance absolute time), but what is usually considered as an aberration (apparent deviation of the transport) will occur for every coordinatization.

The group velocity of electromagnetic wave transforms under Galilean boosts as a particle velocity, and so by the Galilean velocity addition relations. This is expected for the velocity of energy transport. The phase velocity has the same transformation property only when the group and phase velocities are parallel. First we give the basic definitions. Consider a plane wave $\exp(i\Phi)$ of frequency ω and wave vector \vec{k} where the wave phase $\Phi = \omega t - \vec{k} \cdot \vec{x}$. The phase velocity \vec{v}_p is defined to have magnitude $v_p = \omega/k$, and to be normal to the wavefront (and so parallel to \vec{k}). The group velocity \vec{v}_g is defined as the gradient in wave-vector space of the frequency ω : $\vec{v}_g = \nabla_{\vec{k}}\omega$.

When the illumination of the object originates from a monochromatic spatially coherent source there exist a method for calculating the reflection intensity that has the special appeal of conceptual simplicity. The present

⁴ There is no specific, important physical difference between the wavefront and phase front. It is just a question of usage.

approach to this problem uses the Fourier transform methods of spatial filtering theory or Abbe diffraction theory.

When we are dealing with linear systems it is useful to decompose a complicated input into a number of more simple inputs, to calculate the response of the system to each of these elementary functions, and to superimpose the individual responses to find the total response. Fourier analysis provides the basic means of performing such a decomposition. Consider the familiar inverse transform relationship $g(x) = \int_{-\infty}^{\infty} G(K) \exp(iKx) dK$ expressing the profile function in terms of its wavenumber spectrum. We may regard this expression as a decomposition of the function $g(x)$ into a linear combination (in our case into an integral) of elementary functions, each with specific form $\exp(iKx)$. From this it is clear that the number $G(K)$ is simply a weighting factor that must be applied to elementary function of wavenumber K to synthesize the desired $g(x)$.

We have discussed some properties of waves. It has been an exercise in mathematics. Now we will try to apply these properties to the particular case of reflection from a mirror moving transversely. Whenever confronted with new problems, one selects from this store of physical pictures the ones likely to be applicable. A study of the scattering by an individual sinusoidal waveforms a very good preliminary to the more complicated general case. The essence of Abbe's approach in our case of interest is that one regards the mirror as a kind of diffraction grating which breaks up the incident beam of the plane wave into a number of diffracted beams of plane waves. Each of these beams corresponds to one of the Fourier components into which the reflected power of the mirror can be resolved. The mirror with stepped profile is a non-periodic object. It gives an infinite number of diffracted beams forming a continuum.

Diffraction gratings are devices which are used to analyze the frequency content of multicolored light. A simple example of a diffraction grating is shown in Fig.5. Let us assume that the reflectance of the grating varies according to the law $R = g(K_{\perp}) \cos(\vec{K}_{\perp} \cdot \vec{r})$. The reflectance is sinusoidally space-modulated. It should be note that the permanent reflectance distribution grating discussed here is only our mathematical model and we do not need to discuss how it can be created.

The \vec{k} vectors shown in Fig.5 represents the propagation vector of the incident plane wave \vec{k}_i , which is assumed to be directed perpendicularly to the surface. The vectors $\vec{k}_s^{(+)}$ and $\vec{k}_s^{(-)}$ are added to indicate the scattered light. The Bragg condition $\vec{k}_s = \vec{k}_i \pm \vec{K}_{\perp}$ shows how the direction of the incident and scattered wave are related. The first-order maxima dominate due to the fact that light is being scattered from a sinusoidal grating, rather than a set

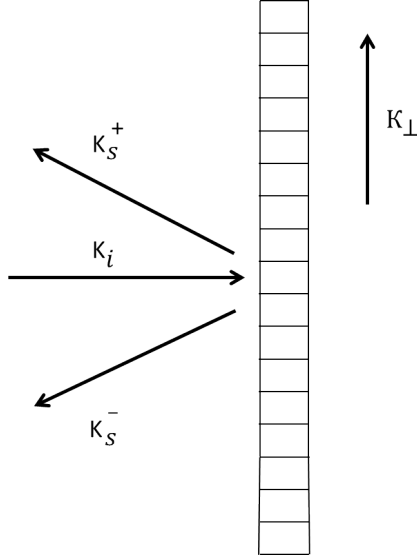

Fig. 5. The Bragg diffraction grating at normal incidence. The reflectance is sinusoidally space-modulated.

of discrete planes (grooves).

We assume that the \vec{k}_\perp vector is located parallel to the side of the diffraction grating with the incident wave impinging on the grating perpendicularly, as shown in Fig.5. The length of the vectors \vec{k}_s and \vec{k}_i must, of course, be the same, but the vector diagram does not quite match up. The Bragg conditions are then not satisfied precisely. For small angles, $\vec{k}_s = \vec{k}_i \pm \vec{K}_\perp$ still holds approximately, so that we obtain the scattering angle $\theta = K_\perp/k_i$.

Now we go on to consider some examples of the effects of moving sources. When a wave which is doing the scattering is a progressive wave rather than a fixed refractive index (susceptibility) modulation, the frequency of the scattered wave is different from that of the incident wave. This fact is interpreted as a Doppler effect since the reflection is from moving rather than a stationary set of waves.

In the case of transversely moving grating, light in the diffraction maxima undergoes a Doppler shift resulting from the fact that it has been reflected from moving waves with wavenumber vectors \vec{K}_\perp . In our present case index changes in a scattering wave would travel at the speed of mirror v . The Doppler shift, $\Delta\omega$, of a scattered light wave is given by $\Delta\omega = \vec{K}_\perp \cdot \vec{v} = \omega_i \theta v/c$, where ω_i is the frequency of light incident on the grating.

There is another interpretation that we can give to the scattering process. We note the very close correspondence between angular and frequency response of moving diffraction gratings and the Raman scattering [11]. Since the theory of Bragg diffraction applies to light scattering by sound waves in

liquids and solids, it is not surprising that we can obtain our results from the quantum theory of light scattering by phonon⁵.

The different wavenumber vectors propagate out from the mirror with the appropriate group velocity in the x direction $(v_g)_x = \Delta\omega/\Delta k_x$, where the $\Delta\omega$ is the Doppler shift $\Delta\omega = \vec{K}_\perp \cdot \vec{v}$ and the Δk_x in our case of interest is simply the transverse component of the scattering wavenumber vector $\Delta k_x = K_\perp$. Then $\Delta\omega/\Delta k_x = v$. The last equation states that group velocity vector (\vec{v}_g) is equal for each scattered waves independently on the sign and the magnitude of the scattered angle $\theta = K_\perp/k_i$.

There is a different physical viewpoint on the group velocity of the light beam scattered from the moving mirror that is equivalent to the presented above. As one of the consequences of the Doppler effect, we find angular frequency dispersion of the light waves reflected off the finite aperture moving mirror. If $\vec{n} = \vec{k}/|\vec{k}|$ denotes a unit vector in the direction of the wave normal, and \vec{v} is the mirror velocity vector relative to the lab frame, we get the equation $\omega_s = \omega_i(1 + \vec{n} \cdot \vec{v}/c) = \omega_i + (\omega_i v/c) \cos \theta$. The Doppler effect is responsible for angular frequency dispersion to the first order of v/c even when $\vec{n} \cdot \vec{v} = 0$ (i.e when $\cos \theta = 0$). In fact, $d\omega_s/d\theta = -(\omega_i v/c) \sin \theta = -\omega_i v/c$ at $\theta = \pi/2$. Now let's see how we can rewrite this equation. Here the differential of the scattered angle is given by $d\theta = -dk_x/k_i$. With the help of this relation and account to that $k_i = \omega_i/c$ we have $d\omega_s/dk_x = v$. There are two different approaches that produce the same result⁶.

⁵ This scattering process is also known as Brillouin scattering. The quantum theory leads to equation $\vec{k}_s = \vec{k}_i \pm \vec{K}_\perp$ by the requirement that the momentum is conserved between interacting photon and phonon. The process of Brillouin scattering is a special case of Raman scattering. Either the incident light photon emits a phonon and radiates the remaining energy as another photon or a phonon is absorbed as the incident light photon is converted to the scattered photon. The momentum balance for scattering involving the emission or absorption of phonon leads to the Bragg condition. The requirement of conservation of energy leads to the equation $\omega_s = \omega_i \pm \omega_{phon}$ with ω_s , ω_i , and ω_{phon} being the radian frequencies, of the scattered photon, the incident photon, and the phonon. The frequency shift that occurs for light scattering from sound waves comes about as a result of the Doppler effect. Quantum mechanically, it is a consequence of the conservation of energy between the participating particles.

⁶ We would like to emphasize an important point. Let us go back to our calculation of the Doppler effect, which led to $\omega_s = \omega_i + (\omega_i v/c) \cos \theta$. According to textbooks, when the mirror moves parallel to itself the frequency of incident light is equal to that of reflected light. Let us write out the formula describing the reflection from the mirror moving along the normal to its plane in the case when the velocity of the mirror is small. Ignoring all terms of the order v^2/c^2 , we get $\omega_s = \omega_i + 2(\omega_i v/c) \cos \theta$. Why our expression for the Doppler shift differs by a factor of 2? The reason for the frequency shift being different is due to the fact that, according to our assumption,

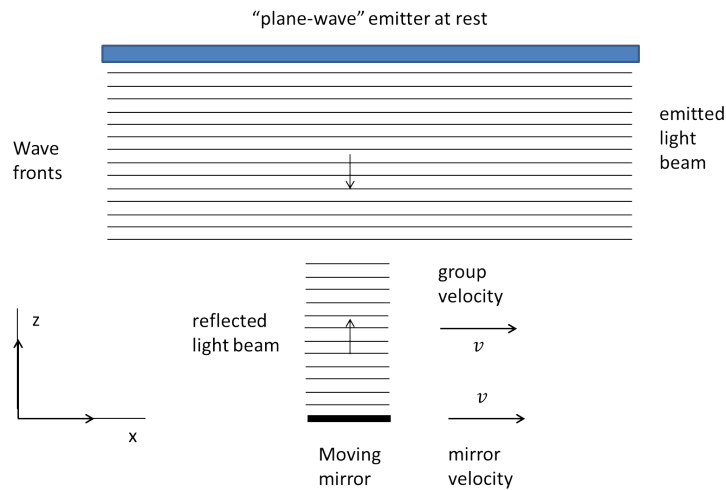

Fig. 6. Transversely moving mirror with a small aperture at the normal incident. When a plane wave of light is falling normally on the mirror, there is the deviation of the energy transport for the reflected light beam. This effect is a consequence of the fact that the Doppler effect is responsible for the angular frequency dispersion of the light waves reflected from the mirror. As a result, the velocity of the energy transport is not equal to the phase velocity.

One of the most important conclusions of the foregoing discussion was that there is a remarkable prediction on the theory of the aberration of light concerning the deviation of the energy transport for light reflected from a mirror moving transversely. Namely, when a plane wave of light is falling normally on the mirror, there is the deviation of the energy transport for reflected light beam (see Fig. 6). This phenomenon could be regarded as a simple consequence of the Doppler effect.

It is a lot easier in physics when we use the absolute time coordinatization. Our physical pictures are readily acquired in conjunctions with our other faculties. The mathematical problem is not unlike the one we met in the case of transversely moving grating at the normal incident. This theory of Bragg diffraction applies to light scattering by sound waves in liquid and solids. The frequency shift that occurs for light scattering from sound waves comes about as a result of the Doppler effect.

4.1.2 Convention-dependent and convention-invariant parts of the theory

Whenever we have a theory containing an arbitrary convention, we should examine what parts of the theory depend on the choice of that convention

the wavenumber vector of the incident plane wave is perpendicular to the velocity vector. Only the scattered plane wave has the component of its wavenumber vector along the velocity direction.

and what parts do not. We may call the former convention-dependent and the latter convention-invariant parts. Clearly, physically meaningful measurement results must be convention-invariant. The phase front (i.e. the plane of simultaneity) orientation has no exact objective meaning since, due to the finiteness of the speed of light, we cannot specify any experimental method by which this orientation could be ascertained. In contrast, the direction of radiation beam propagation (i.e. the direction of energy propagation) has obviously an exact objective meaning.

With the viewpoint of the electrodynamics mirror and emitter is entangled system. We can prepare for mirror and emitter common set of synchronized clocks in the lab frame only in the case of the absolute time coordinatization i.e in the case when simultaneity is absolute. According to the choosing absolute time coordinatization, the lab observer actually sees the radiation beam after the reflection as a result of a Galilean boost rather than a Lorentz boost. The simultaneity along the x direction has an absolute character, meaning that it is independent of the reflection and the radiation phase front remains unvaried. Today the statement about the correctness of Galilean transformations is a "shocking heresy", which offends the generally accepted way of looking at special relativity of most physicists. The argument that in the process of reflection from a transversely moving mirror the direction of propagation is not given by the normal to the wavefront is considered in the literature as erroneous.

To quote Norton [12]: "One might try to escape the problem by supposing that the direction of propagation is not always given by the normal to the wavefront. We might identify the direction of propagation with the direction of energy propagation, supposing the latter to transform differently from the wave normal under Galilean transformation. Whatever may be the merits of such proposals, they are unavailable to some trying to implement a principle of relativity. If the direction of propagation of a plane wave is normal to the wavefronts in one inertial frame then that must be true in all inertial frame."

It is impossible to agree with this statement. It indicates that the author does not understand the difference between the convention-dependent and convention-invariant parts of the theory. The direction of energy transport obviously has exact objective meaning i.e convention-invariant. However, the simultaneity of events is convention-dependent and has no exact objective meaning. It is important at this point to emphasize that, consistently with the conventionality of simultaneity, also the orientation of the phase front (i.e. plane of simultaneity) is a matter of convention and has no definite objective meaning.

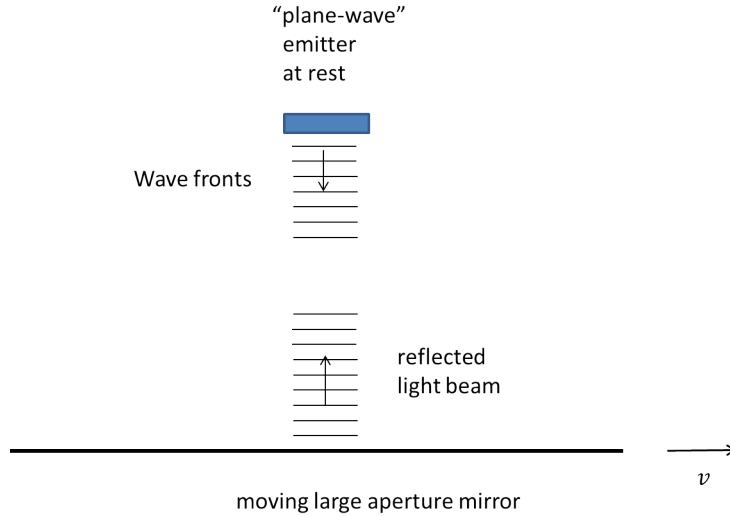

Fig. 7. Transversely moving mirror with a large aperture at the normal incident. When a beam of light is falling normally on the mirror, there is no deviation of the energy transport for the reflected light beam. We have actually the problem of steady-state reflection. The velocity of the energy transport is equal to the phase velocity.

4.1.3 Large aperture mirror

Now we go on to consider other asymptotes of the aberration effect from a transversely moving mirror. Let us suppose that the transverse size of the moving mirror is very large relative to the transverse size of the “plane-wave” emitter. It is easy to show that the deviation of the energy transport is absent in a large aperture mirror case, Fig.7. Let us try to see why. The way of thinking that made the law about the behaviour of reflected light evident is called “Abbe’s approach”. The idea is that we might regard the moving mirror as a kind of moving diffraction grating which breaks up the incident beam into a number of diffracted beams of plane waves. Each of these beams corresponds to one of the Fourier components into which reflected light beam can be resolved. We call attention to the fact that if the transverse size of the incoming light beam D_e is much less than the transverse size of the mirror D_m , the group velocity of the scattered beams is dramatically reduced. This suppression is not surprising, if one analyzes the expression for the group velocity $(v_x)_g = \Delta\omega/\Delta k_x$. In fact, the Doppler shift of a light wave reflected from the moving grating is given by $\Delta\omega = \vec{K}_\perp \cdot \vec{v}$. But the transverse component of the scattering wavenumber vector Δk_x in our case of interest can be written as $\Delta k_x = (k_x)_i + K_\perp$, where $(k_x)_i$ is the transverse component of the incoming wavenumber vector \vec{k}_i . In the large aperture mirror case we have $(\Delta k_x)_i \gg K_\perp$, hence $\Delta\omega/\Delta k_x \sim (D_e/D_m)v \ll v$. So we begin to understand the basic machinery of reflection from a transversely moving mirror: in order to discuss the group velocity of the reflected beam,

we must have the size D_e of the light beam greater than the characteristic spacing of the grating. This equivalent to the assumption $K_{\perp} D_e \sim D_e/D_m \gg 1$ made above in the previous discussion about the reflection from a small aperture mirror.

4.2 *Direction of the energy transport from the moving observer's point of view*

Now we wish to continue in our analysis a little further. We will look for a different way of calculating the aberration effect. Above we have been studying what happens in the lab frame when a mirror moves with velocity v parallel to a "plane-wave" emitter. In this section, we will try to understand what goes on in two reference frames: one fixed with respect to the emitter, and one fixed with respect to the mirror. We will call the first (lab) frame S and the second S' .

In the frame S' , where a mirror is at rest, we have only a choice between a Lorentz time coordinate for the moving emitter and Lorentz time coordinate for the mirror. The most natural choice is the Lorentz coordinatization for the mirror. In other words, we suppose that in the S' frame (where the mirror is at rest) the procedure of slow clock transport is used to assign values to the time coordinate t' . According to the principle of relativity, usual Maxwell's equations can always be used in any Lorentz frame where the source is at rest. In particular, reflected radiation will be generated and described with the help of Maxwell's equations in their usual form. In the frame S' we consider the case when the emitter is moving with velocity $-v$ along the x -axis. We suppose that in the S frame (where the emitter is at rest) also the procedure of slow clock transport is used to assign values of the time coordinate t . Accepted synchronization convention preserves simultaneity and is actually based on the absolute time (or absolute simultaneity) convention. The Cartesian coordinates of the mirror transform as $x' = x - vt$, $y' = y$, $z' = z$. This transformation completes with the invariance of simultaneity, $t' = t$. As a result, the transformation between frames has the form of a Galilean transformation.

4.2.1 *Small aperture mirror*

Suppose that an observer, moving with the small aperture mirror, performs the direction of the energy transport measurement. Then how does the reflection looks? It looks as though the reflected beam is going perpendicular to its phase front because it has lost its group velocity. This is plausible if one keeps in mind that in the frame S' where the small aperture mirror is at rest one actually solves the steady-state problem of light reflection, Fig. 8.

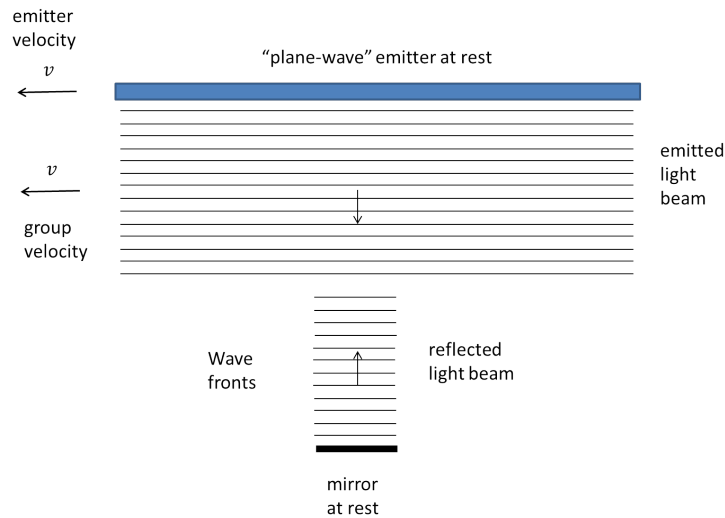

Fig. 8. A "plane-wave" emitter is moving tangentially to its surface. The deviation of the energy transport for the radiated light beam is a consequence of the fact that the Doppler effect is responsible for angular frequency dispersion of the light waves radiated by the emitter. A small aperture mirror is at rest. There is no deviation of the energy transport for the reflected light beam.

We want to raise the following interesting and important points. The laws of physics in any reference frame should be able to account for all physical phenomena, including the observations made by moving observers. Suppose that an observer in the S frame performs an aberration effect measurement. The lab observer can directly measure the direction of the radiation beam propagation. To measure the direction of radiation, a detector at rest in the lab frame can be used. It is assumed that the detector aperture is sufficiently large compared with the measured beam size. The observer in the frame S' where a mirror is at rest sees that the lab detector is moving with a given velocity and the lab observer, moving with the detector, performs the radiation direction measurement. Then when the lab detector measurement is analyzed, the observer in the frame S' finds that the measured deviation of the energy transport consistent with the results of the analysis in the lab frame presented above, as must be.

4.2.2 Large aperture mirror

We shall now discuss the situation where in the S' frame there is a small aperture "plane-wave" emitter moving tangentially to its surface. For simplicity, we shall assume that the transverse size of the moving "plane-wave" emitter is very small relative to the transverse size of the mirror. We must emphasize that in the frame S' , where the small aperture emitter is moving, we have actually the problem of non steady-state reflection. As one of the consequences of the Doppler effect, we find the group velocity of

the light waves radiated off a small aperture moving emitter. Then how does the reflection look? In the S' frame, the mirror is at rest, so the usual laws of optical reflection apply. Clearly, the horizontal component of the group velocity is conserved: it is the same before and after the reflection. This is plausible if one keeps in mind that a light signal represents a certain amount of electromagnetic energy and that energy, like mass, is a conserved quantity, so that a light signal in many respects will resemble a material particle.

4.3 Discussion

We would like, finally, to summarize the results of this section. We are now in the position to formulate the following general statement: the deviation of energy transport (i.e. the aberration of light phenomenon) takes place only when we have a deal with time-dependent (emitter-mirror) problem parameters. Let us consider at first the deviation of energy transport for a small aperture mirror which is moving tangentially to its surface. What must be recognized is that in the time-dependent emitter-mirror problem, the solution makes reference to the light beams with different frequencies. Indeed, we demonstrated that the Doppler effect in this case results directly from the time-dependence of the transverse position of the moving mirror (emitter) with finite aperture. The deviation of the energy transport comes from the (transverse) group velocity of the reflected beam. How shall we calculate the group velocity? It is like an electromagnetic problem with angular-frequency dispersion due to the Doppler effect.

5 How to solve a problem involving emitter-scatter relative velocity

Our earlier discussion in Section 4 is really about as far as anyone normally need to go with the subject, but we are going to do it all over again a different way. We will get the same answers as before, but now from a straightforward solution of the electrodynamic problem, rather than by some clever arguments.

5.1 Choice of space-time coordinates system in the lab frame

We go back now to the situation shown in Fig.6 and start with the formulation of the initial conditions. Let us suppose that the small aperture mirror moves with velocity v along the x -axis of a Cartesian (x, y, z) system in the

lab frame. As an example, suppose that the "plane-wave" emitter is at rest in the lab frame and radiates plane phase front in the vertical direction i.e. perpendicular to the velocity v . How to measure this mirror velocity and the orientation of the radiation phase front? First, how is the velocity of the mirror found? The velocity is determined once the coordinates in the lab frame are chosen, and is then measured at appropriate time intervals along the mirror trajectory. But how to measure a time interval between events occurring at different points in space? In order to do so, and hence measure the velocity of a mirror within a single inertial lab frame, one first has to synchronize distant clocks. If we have adopted a method for timing distant events (i.e. a synchronization convention), we can also specify a method for measuring the orientation of the radiation phase front.

5.1.1 *Operational interpretation of the absolute time coordinatization*

The question now arises how to assign synchronization in the lab frame. We need to give a "practical" ("operational") answer to this question. The most natural method of synchronization consists in putting all the ideal clocks together at the same point in space, where they can be synchronized. Then, they can be transported slowly to their original places (slow clock transport)⁷. This time synchronization convention preserve simultaneity and actually based on the absolute time (or absolute simultaneity) convention. For mirror and emitter, we have one (common) set of synchronized clocks in the lab frame and the synchronization of these clocks is independent on the mirror velocity. According to the particular choice of synchronization convention, relativistic kinematics effects such as relativity of simultaneity does not exist in the lab frame.

5.1.2 *Electrodynamics of moving bodies and the absolute time coordinatization*

The usual Maxwell's equations are valid in any inertial frame where the sources are at rest and the procedure of slow clock transport is used to assign values to the time coordinate. In the lab frame, the emitter is at rest and the field equations involved in the description of emitter radiation are constituted by the usual Maxwell's equations. Consequently, the direction of radiation beam propagation is given by the normal to the phase front.

⁷ The theory of relativity offers an alternative procedure of clocks synchronization in the lab frame. Einstein's synchronization is defined in terms of light signals emitted by the dipole source (e.g. a light laser source) at rest in the lab frame, assuming that light propagates with the same velocity c in all directions. If and only if the synchronizing laser is at rest in the lab frame the slow transport synchronization is equivalent to Einstein synchronization.

Now, what about the reflection from a mirror moving transversely? We would like to start with the kinematics of the light beam reflection. This is easy to do. In the absolute time coordinatization, the simultaneity of a pair of events has absolute character. So the simultaneity along the x direction has an absolute character, meaning that it is independent of the reflection and the radiation phase front remains unvaried.

We have already discussed that the orientation of the radiation phase front is not a real observable effect; now we have to discuss the observable effects. Let us consider the electrodynamics of the moving mirror. The explanation of the phenomenon of reflection in our case of interest consists in using a Galileo boost to describe the uniform translational motion of the mirror in the lab frame. Maxwell's equations are not preserved in form by the Galilean transformation, i.e. Maxwell's equations are not invariant under Galilean transformation. In particular, after the Galilean transformation of the wave equation for scattered light we obtain Eq.(1). The choice of the absolute time coordinatization implies to use of anisotropic field equations for the reflection description. The direction of the energy propagation is not given by the normal to the phase front of reflected light.

We already know from our discussion in Section 4 that the group velocity of the light scattered from the moving grating is one of the Doppler effect consequences. First, we want to rise the following important point. The laws of electrodynamics in any reference frame should be able to account for all electrodynamics phenomena, including the Doppler effect. The new terms that have to be put into the field equations due to use of Galilean transformation lead to the prediction of the Doppler effect as must be.

How we shall to solve the electrodynamics equations after the Galilean transformation? Consider as a possible solution a scattered plane wave $\exp(i\vec{k}\cdot\vec{r}-i\omega t)$. With a plane wave $\exp(i\vec{k}\cdot\vec{r}-i\omega t)$ with the wavenumber vector \vec{k} and the frequency ω equation Eq.(1) becomes: $k_x^2 + 2vk_x\omega/c + k_z^2 - \omega^2/c^2 = 0$. From initial (time dependent) conditions we will find it necessary to use \vec{k} as independent variable and we will consider ω as a function of k_x : $\omega = \omega_i + \Delta\omega(k_x)$, where ω_i is the frequency of the incoming plane wave. The wavenumber vector of the scattered plane wave is fixed by initial conditions. In fact, $k_z = \omega_i/c$, $k_x = K_\perp$, where K_\perp is the wavenumber of sinusoidally space-modulated grating reflectance. From this dispersion equation, we find the requirement that the wavenumber K_\perp and the frequency change $\Delta\omega$ are related by $\Delta\omega = K_\perp v$. The new terms that have to be put into the field equations due to the use of Galilean transformation lead to the same prediction as concerns (convention independent) experimental results: the reflected light beam is moving with group velocity v along the x axis.

5.2 *An alternative basis for the explanation of the effects at first order in v/c*

The described method, which is in complete agreement with the theory of relativity (as the theory of space-time with pseudo-Euclidean geometry), can, however, as shown by Lorentz, easily be explained on the basis of the ether theory if we may assume that terms of the second-order are below the accuracy of the experiments.

Suppose that electromagnetism is a mechanical phenomenon that happens in a material medium. Then Maxwell's equations will be valid only in the inertial frame fixed to that medium (ether). The speed c of light propagation in ether must be regarded as a property of the medium. The ether is supposed to represent the absolute system of reference, thus giving a substantial physical meaning of Newton's notion of absolute space. In the present subsection, we shall fully adopt this point of view, and our task will be to see what consequences this will have for the course of development of optical phenomena in an inertial system moving relative to the ether. We will show that the deviation of the energy transport phenomenon occurring in our special experimental arrangement depends only on the velocity of the mirror with respect to the lab frame. The aberration of light effect does not depend on the velocity of the lab frame with respect to the ether. The absolute velocity of the emitter (mirror) enters only in the small second-order terms.

In the frame fixed to the ether, Maxwell's equations will be valid and light travels with speed c in all directions. If, for instance, we assume that the lab frame is at rest relative to the ether, then we can find the radiation fields for the emitter and the moving mirror from Maxwell's equations. The velocity of the waves is independent of the motion of the mirror with respect to the lab frame (i.e. with respect to the ether). Thus, the explanation of the Doppler effect posed no difficulty. This assertion is best explained with the example of the Doppler effect for sound waves in air. We can now reproduce the reasoning in Section 4. If the ether is stationary in the lab system, it follows from the (Doppler) angular frequency dispersion that the deviation of the energy transport consistent with the results of the analysis presented above.

Let us now consider an emitter-mirror experiment where the mirror is at rest relative to the ether. Then we have in the lab frame, where the mirror is transversely moving with velocity v , an ether wind with velocity $-v$. This wind implies to use of anisotropic field equations for reflection description. The explanation of the phenomenon of reflection in the case of an ether wind consists in using a Galileo boost to describe the uniform translational motion of the mirror in the lab frame. The direction of the energy propagation is not given by the normal to the phase front of reflected light. The new

terms that have to be put into the field equations due to the use of Galilean transformation lead to the same prediction as concerns experimental results: in the lab frame the reflected light beam is moving with group velocity v along the x axis. Thus the deviation of the energy transport is the same where the lab frame was at rest in the ether.

We remark again that there is an agreement between the ether theory and the theory of relativity as regards all optical effects of the first order. At this point, a reasonable question arises: since the classical ether theory was developed without accounting for the pseudo-Euclidean geometry of space-time continuum, how this theory can help us in the complicated case of the entangled emitter-mirror system? However, this is not too surprising, if one analyses the kinematics of the ether theory. The study of the optical phenomena in the emitter-mirror system according to the ether theory is intimately connected with the "old" Newton kinematics: the absolute time (simultaneity) convention is actually used. In the ether theory, one can find the radiation fields for the emitter and the moving mirror from Maxwell's equations. It is important to emphasize that in the ether theory electromagnetism is a mechanical phenomenon which happens in a material medium and one must additionally account for the Doppler effect.

When we were dealing with the entangled system we also used absolute time coordinatization to perform our analysis. The authors of textbooks got the incorrect result by using an incorrect physical argument. This wrong argument is an assumption about common Lorentz time coordinate in the lab frame for both mirror and emitter. We demonstrated that we can prepare for mirror and emitter common set of synchronized clocks in the lab frame only in the case of the absolute time coordinatization i.e in the case when simultaneity is absolute. We can find the radiation field for emitter from Maxwell's equations, but for the mirror, we used anisotropic (Galilean transformed) field equations. These equations give the important result that there is a Doppler effect for scattered plane waves. Actually using the space-time geometric approach at the first order in v/c we can solve the electromagnetic problem using Maxwell's equations (which are the isotropic equations). Nevertheless the results will depend on the direction of the velocity vector of the mirror due to the Doppler effect: if the mirror moves towards us the light it scatters more violet, and if it moves away it appears more red.

5.3 *Failure of Einstein's approach*

While the results in this paper are fundamental, there is nothing unexpected about them, except perhaps that they can be derived using pre-relativistic theory only, and thus that they could have been proven long ago.

We demonstrated that the aberration of light effect in our case of interest results directly from the time-dependence of the position of the moving mirror with finite aperture. What must be recognized is that in the time-dependent emitter-mirror problem, the solution makes reference to the light beams with different frequencies. It comes out quite natural that the results will depend on the velocity vector. The central result of this paper is that we have shown that the authors of textbooks overlooked the influence of the Doppler effect. This is surely a conceptual mistake.

First of all, we know that all natural phenomena follow the principle of relativity, which is a restrictive principle: it says that the laws of nature are the same (or take the same form) in all inertial frames. In agreement with this principle, usual Maxwell's equations can always be exploited in any inertial frame where electromagnetic sources are at rest using the Einstein's synchronization procedure in the rest frame of the source. The fact that one can deduce electromagnetic field equations for arbitrary moving sources by studying the form taken by Maxwell's equations under the transformation between rest frame of the source and the frame where the source is moving is a practical application of the principle of relativity. Since we require two coordinate systems, the question now arises on how to assign a time coordinate to the lab frame.

Coordinates serve the purpose of labeling events in an unambiguous way, and this can be done in infinitely many different ways. However, we are better off using Lorentz coordinates when we want to solve the electrodynamics problem in the lab frame based on Maxwell's equations in their usual form. In fact, the use of other coordinate systems also implies the use of more complicated (anisotropic) electromagnetic field equations. In other words, the principle of relativity dictates that Maxwell's equations can be applied in the lab frame only in the case when Lorentz coordinates are assigned.

The wrong argument that the results of reflection will not depend on the velocity vector can be summarized in the following way. It is incorrectly believed that any electrodynamics problem can be treated within the same "single Lorentz frame" description. At first glance, the ordinary rules of Einstein's approach tell us how to assign the Lorentz time coordinate to the lab reference frame. The generally accepted result is that one can always prepare, for emitter and mirror, a common set of synchronized (according to Einstein's procedure) clocks in the lab frame. So, what would happen, according to Maxwell's equations, if the mirror moves in the Lorentz lab frame and the "plane-wave" emitter is at rest in the same Lorentz lab frame?

Authors of textbooks found that, for this case, Maxwell's electrodynamics predicts exactly the same effect as when the mirror is at rest. According to the common (Lorentz) time coordinate axis for emitter and mirror, the

simultaneity along the direction of mirror motion is independent of the reflection and the radiation wavefront remains unvaried. The velocity of the energy transport is equal to the phase velocity as it must be in Maxwell's electrodynamics. In fact, according to Maxwell's equations, the wavefront of a light beam is always orthogonal to the propagation direction. It should be noted that Maxwell's theory has no intrinsic anisotropy. We can consider the amplitude of the beam radiated by the plane of oscillating electrons as a whole to be the resultant of radiated spherical waves. The results will not depend on the velocity vector.

This incorrect statement is a straightforward consequence of the generally accepted way of looking at special relativity of most physicists. Einstein's approach, as we have mentioned before, fails to predict the deviation of the energy transport for light reflected from a transversely moving mirror. Now we can see the reason. Accepting the postulate on the constancy of the speed of light in all inertial frames we also automatically assume Lorentz coordinates and the fact that different inertial frames are related by Lorentz transformations. According to such limiting understanding of the theory of relativity, it is assumed that only Lorentz transformations must be used to map the coordinates of events between inertial observers.

We already pointed out that the essence of the special theory of relativity consists in the following postulate: all physical processes proceed in four-dimensional space-time, the geometry of which is pseudo-Euclidean. The consequence of this postulate is the remarkable prediction on the theory of aberration of light concerning the deviation of the energy transport for light reflected from a mirror moving transversely. This phenomenon could be regarded as a simple consequence of space-time geometry.

6 Analysis of transmission through a hole in a moving opaque screen

6.1 Diffraction of light by a screen

We are now in a position to take up a somewhat different matter which we can handle with the machinery of the last section. Above we demonstrated that when one has a small aperture mirror moving transversely and the plane wave of light is falling normally on the mirror, there is the aberration (deviation of the energy transport) for light reflected from the mirror. The problem to be discussed in this section is of more practical importance.

We know from textbooks that when one has an opaque screen at rest and the light comes through some hole, the distribution of intensity (i.e. diffraction

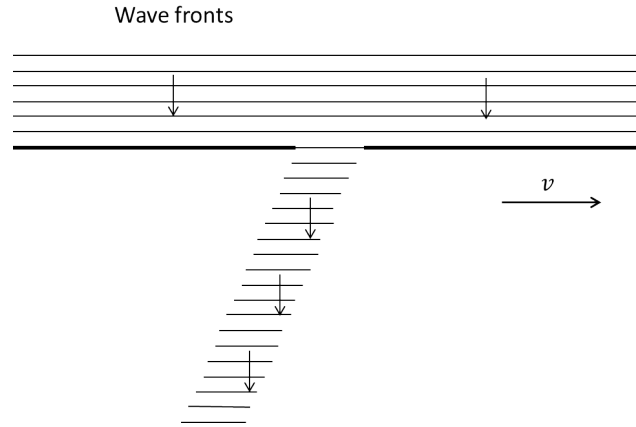

Fig. 9. Transversely moving screen which has a hole in it. According to textbooks, a monochromatic plane wave of light is falling normally on the screen and generates a transmitted oblique beam. There is no deviation of the energy transport for the transmitted oblique light beam. The velocity of the energy transport is equal to the phase velocity.

pattern) could be obtained by imaging instead that the hole is replaced by sources (dipoles) uniformly distributed over the hole. In other words, the diffracted plane wave is the same as through the hole were a new source. This is a particular case of a Babinet's principle which states that the sum of diffraction fields behind two complementary opaque screens is the incident wave.

6.2 Direction of the energy transport from the lab observer's point of view

6.2.1 Small aperture hole

We now consider the acceleration of the screen in the lab frame up to velocity v along its surface. It is generally believed that there is no deviation of the energy transport for light transmitted through a hole in the moving opaque screen, Fig. 9. This idea is a part of the material in well-known books and monographs.

However, there is a common mistake made in the relativistic optics connected with the aberration effect from a transversely moving screen containing a hole. We want to solve this electrodynamics problem based on the Fourier transform method. The essence of the Fourier approach in our case of interest is that one regards the screen containing a hole as a kind of diffraction grating which breaks up the incident beam of the plane wave into a number of diffracted beams of plane waves. Each of these beams corresponds to one of the Fourier components into which a transmitted light beam can be resolved. The hole with a stepped profile is a non-periodic

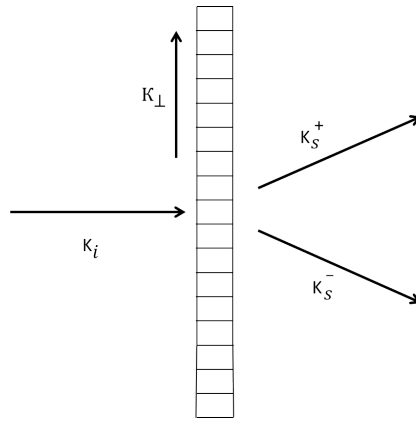

Fig. 10. The Bragg diffraction grating at the normal incident. The transmittance is sinusoidally space-modulated.

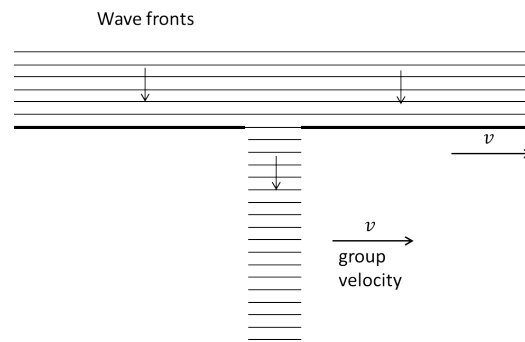

Fig. 11. Transversely moving screen which has a hole in it. A monochromatic plane wave of light is falling normally on the screen and generates a transmitted light beam. The Doppler effect is responsible for the angular frequency dispersion of the light waves transmitted through the hole. As a result, the velocity of the energy transport is not equal to the phase velocity.

object. It gives an infinite number of scattered beams forming a continuum.

The gratings discussed so far modulated the amplitude of the incident plane wave by a periodic reflection function. However, we can immediately extend the range of validity of our analysis to gratings modulated the amplitude of the incident light by a periodic transmission function. Let us assume that the transmittance of the grating varies according to the law $T = g(K_{\perp}) \cos(\vec{K}_{\perp} \cdot \vec{r})$, Fig.10. The transmittance is sinusoidally space-modulated. All the equations that we derived so far hold immediately for the forward scattered beams.

According to the correct space-time coordinatization, there is a remarkable prediction on the theory of the aberration of light concerning the deviation of the energy transport for light transmitted through a hole in the moving screen. Namely, when one has a transversely moving screen which has a hole in it and a plane wave of light is falling normally on the screen, there is

the deviation of the energy transport for light transmitted through the hole (see Fig. 11).

The two interpretations of the aberration effect are shown in Fig. 9 and Fig. 11. They are obviously distinguishable. We should understand that in our case of interest the "plane-wave" emitter is a spatially coherent source. It has been shown in the present treatment that the wave theory approach to the aberration of light leads to a substantially different result for energy transport than the predicted by conventional theory. The conventional theory of the aberration of light phenomenon is incorrect and therefore is not a valid basis to interpret the experimental results.

6.2.2 *Large aperture hole*

Now what about the light transmission through the moving large aperture hole? We know it is child's play to solve the transmission problem for this case. So we have the so-called "child play" case. Does this discussion about large aperture hole have any meaning? To see whether it does, we should remember about the Babinet's principle. We know, from this principle, that the solution we have found also corresponds to that for large aperture mirror. Here we only wish to show how easy the law of the reflection from the moving large aperture mirror can be found with the help of the Babinet's principle.

6.3 *Direction of the energy transport from the moving observer's point of view*

6.3.1 *Small aperture hole*

Suppose that an observer, moving with the screen contained a small aperture hole, performs the direction of the energy transport measurement. At close look at the physics of this subject shows that in the frame S' , where the screen is at rest, we have actually the problem of steady-state transmission. Then how does the transmitted light beam looks? It looks as though the transmitted beam is going vertically because it has lost its horizontal (group velocity) component. That is the transmission appears as shown in Fig.12.

We only wish to emphasize here the following point. When the light passes through the small aperture hole we have a light beam whose fields have been perturbed by diffraction, and now not include information about emitter motion. What are the consequences of this? There are a number of remarkable effects which are a consequence of the fact that the information about source motion is not included into the light beam transmitted through the small hole. In fact, this is the key to the binary star paradox discussed

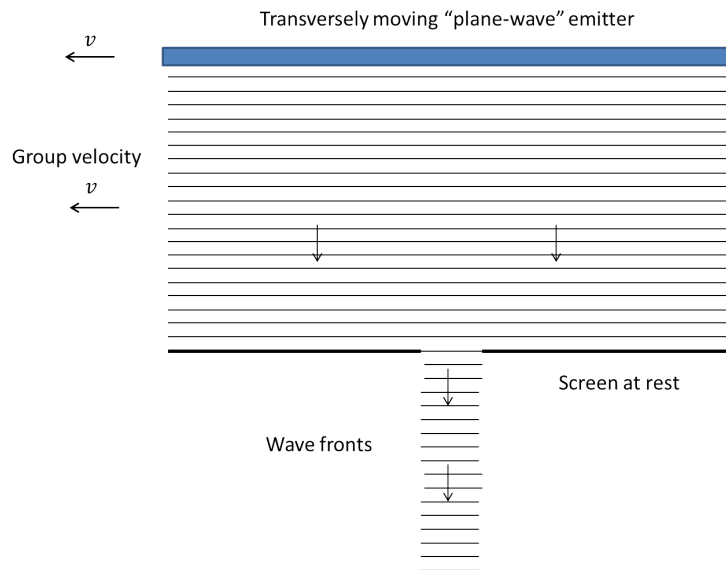

Fig. 12. The large aperture "plane-wave" emitter moving tangentially to its surface. As one of the consequences of the Doppler effect, we find group velocity of the light waves radiated off a large aperture moving emitter. The screen is at rest and we have actually the problem of steady-state transmission. The transmitted light beam is going vertically because it has lost its horizontal (group) velocity component.

here.

6.3.2 Large aperture hole

Following the same arguments we have already used, it is easy to see that the horizontal component of the group velocity is conserved: it is the same before and after the transmission (reflection) in the case of moving small aperture emitter.

6.4 Incoherent limit. Geometric (ray) optics consideration

We would like now to discuss the region of applicability of ray optics in the theory of the aberration of light. The ray analysis in the aberration theory gives the right answer in the case when the relevant spatial coherence length of the light source is much shorter than the hole diameter. In this situation, the direction of the light propagation through the hole in the transversely moving screen can be found with the help of geometrical optics considerations. Now let us see what happens in our case of interest. Geometrical optics is very simple. Spatially incoherent light (rays) is falling normally on the moving screen and, according to literature (see e.g. [13]), generates oblique rays as Fig.13 shows. We just treat incoherent light like little particles

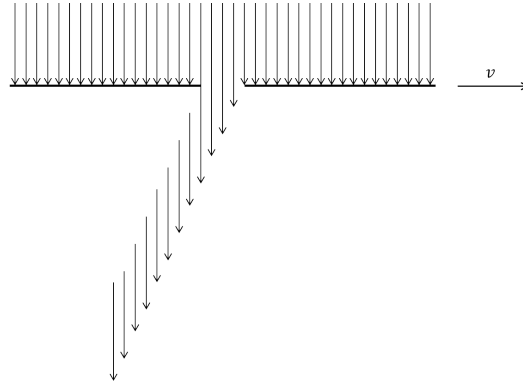

Fig. 13. Transversely moving screen which has a hole in it. Light rays from a spatially incoherent source are falling normally on the screen and, according to literature (see e.g. [13]), generates an oblique ray beam.

in the "raindrop" model and the effect is entirely familiar.

Although the ray analysis implicitly used in the argument above gives an intuitively sound answer, a satisfactory treatment of aberration in the context of the theory of relativity should be based on the electromagnetic wave theory. Generally, the aberration of light phenomenon cannot be treated considering only relative motion between source and observer. In regard to light aberration, one should differentiate between that from the source and that from the observer. In the coherent limit, source and observer motion-induced aberrations should be treated separately. We already demonstrated that there is no aberration proceeding from the spatially coherent sources independently of their motion. However, the existence of an aberration of light rays due to the source motion would lead, in the case of incoherent source, to an aberration angle fixed by the source speed.

7 Measure of aberration

In order to understand the aberration of light according to the wave theory, above we considered a purely illustrated example of a simplified device consisting of the screen which has a hole in it. Fig. 11 explains the situation. Light is falling normally on the screen and generates a transmitted light beam. Imagine that there are two identical devices. The first device is at rest in the lab frame and the second device is moving with a uniform velocity v in the horizontal direction.

Let us consider a detector for the direction of the transmitted light. Suppose that the light beam transmitted through the hole is imaged by a lens to a spot which lies in the focal plane on the optical axis. In this case, the direction of the optical axis is coincident with the direction of the transmitted light

beam.

7.1 *Physical coordinate system in space*

7.1.1 *An illustrative example*

Suppose we are trying to understand what goes on in two reference frames: one fixed with respect to the first device, and one fixed with respect to the second device. In order to detect the aberration effect inside the moving frame, it is obvious that some coordinate system with reference direction is needed. For the coordinate system to be of real use, it must be identical to the coordinate system in the lab frame. We must inquire in detail by what method we assign coordinates. This method involves some sort of physical procedure; eventually, it must be such that it will give us coordinates in both (lab and moving) frames of reference.

It would be well to illustrate a measure of the aberration in the coherent limit by considering the relatively simple example. We will define a reference direction in the following way. Let us suppose that the aberration direction inside the frame is determined with reference to the fixed direction of rays from an incoherent source which is at rest (or moving with constant velocity) in the lab frame. The reference axis is formed by a ray beam. In other words, a conventional graphical referential frame is instead formed here by electromagnetic axis, constitutes by one ray beam, Fig. 14. This is the most primitive system. The motion of the light beams and frames are assumed, for simplicity, to lie in the same ($x - z$) plane and the angular position of the coherent beam is described by one angle. In the coherent limit, such a physical coordinate frame allows us to detect the aberration effect inside the frame. The number that specifies the angular position of the coherent light beam transmitted in the device may be defined as an angle between the coherent and the incoherent light beams.

The motion of the device will result in an apparent change of the coherent beam declination by an amount v/c . The moving observer will interpret this change inside his frame as a change in the ray beam angular position. The lab observer will find no change inside his frame. The law of physics in any reference frame should be able to account for all physical phenomena, including observations made by moving observer. The lab observer would find that the direction of ray beam propagation in the moving device is the same, but the direction of propagation of the coherent beam transmitted in the moving device is altered in consort with the device motion with respect to the lab frame. Then, when the measurement of the moving observer is analyzed, the lab observer finds that the measured aberration angle in the

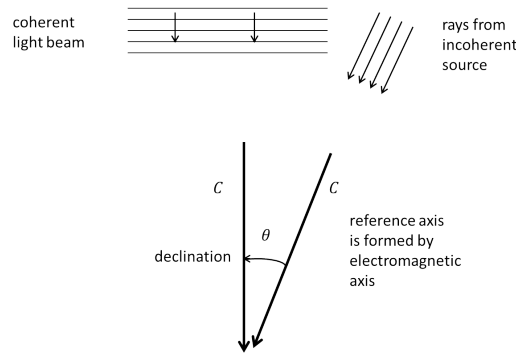

Fig. 14. A physical coordinate frame. The reference electromagnetic axis is formed by a ray beam. The number that specifies the angular position of the coherent light beam may be defined as the angle between the coherent and incoherent light beams.

moving frame is nonzero and consistent with moving observer measurement.

7.1.2 Rule for computing the declination

Suppose that an observer in the moving frame performs an aberration measurement. The moving observer can directly measure an aberration angle of the transmitted coherent beam using a reference axis which is formed by the ray beam. It is assumed, for simplicity, that the declination in the lab frame is equal to zero. The rule for computing the declination is the following. The moving observer takes the velocity of the transmitted ray beam in his device and adds vectorially to it the velocity of his device with respect to the lab frame. The direction of the resulting vector is the apparent direction of the transmitted coherent light beam in the moving device with respect to the ray beam direction.

The lab observer view of the observation of the moving observer is shown in Fig. 15. The simple prescription for computing the declination is the following. The lab observer takes the velocity of the transmitted ray beam in his device and adds vectorially to it the velocity of the moving device with respect to the lab frame. The direction of the compounded motion is the direction of the transmitted coherent light beam in the moving device with respect to the ray beam direction.

7.2 Problems connected with representation systems of space coordinates

It must be added to the above considerations that the physical procedure described above provides necessary conditions for the behaviour of reference axes. It quite clear that dynamical processes within an inertial frame

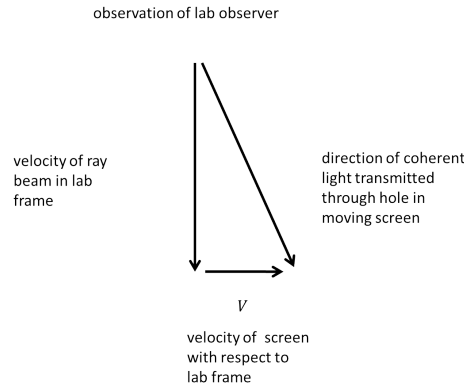

Fig. 15. The rule for computing the declination. Lab frame view of the observation of the moving observer. It is assumed, for simplicity, that the declination in the lab frame is equal to zero. Clearly, the angular displacement of the coherent light beam propagation in the moving frame compared with conventional prediction differs in sign.

can be described in the coordinate representation only in the case when a physical system of reference does not involve in dynamical interactions. We determine the reference axis using light which is supposed to behave like rays. Using a system of reference such obtained we assert that electromagnetic axis not (electro) dynamically interact with our devices. In fact rays, in contrast with the coherent light beam, are not scattered by the hole edges. The deviation of the energy transport for the coherent light beam transmitted through the hole is (electro) dynamics effect.

We have just shown that, in our system of space coordinates, from the measurement, we cannot determine the observer motion-induced aberration of the ray beam. We see clearly that coherent light beam aberration describes a situation in which assumes the true direction of a light ray to be the same for two observers in relative motion, and consequently infers that the apparent direction of the coherent light must be different for the observers. The aberration of a coherent light is considered independent of the source velocity and to have just a local origin exclusively based on the observer velocity⁸.

7.3 Axis perpendicular to the ecliptic plane as common reference direction

Above we have shown that making use of a ray beam radiated from an incoherent light source we can obtain a coordinate system in space which

⁸ Aberration of the incoherent source (with respect to the reference incoherent source) is also unsymmetrical with respect to the velocities of observer and source. The aberration of the incoherent source is considered independent of the observer velocity and to have just exclusively based on the source velocity.

satisfies necessary conditions to the behaviour of the physical reference system. The question arises whether it is possible to find another physical coordinate system in space for moving frame which is identical to the coordinate system in the lab frame? Clearly, it is possible to define a reference direction using a gyroscope. Let us suppose that the aberration direction (i.e. the direction of the optical axis) inside the frame is determined with reference to the fixed spinning axis of a gyroscope. The aberration describes a situation in which one assumes the true direction of a spinning axis to be the same for two observers in relative motion and consequently infers that the apparent direction of the coherent beam must be different for the observers. We would note here that so far we have been discussing physical coordinate systems in space for moving frame which is identical to the coordinate system in the lab frame. The equivalence of all such physical frames of reference underlies the theory of relativity, so when the aberration angle emerges, it emerges in the same manner in all such physical reference systems.

We have shown how one can use a simplified device to detect the aberration of light phenomena. Altogether, the described experiment is fundamentally similar to the procedure of stellar aberration measurement. It can be demonstrated that the light produced by a distant star is approximately coherent over a circular area on the earth's surface, whose diameter in all practical cases is much larger than the telescope diameter. For all observations of the aberration of a star, certain directions and orientations must be established as standards. To establish such a standard space direction, the earth's revolution about the sun can be considered as an enormous gyroscope. The aberration direction is determined with reference to the fixed spinning axis. This axis is oriented perpendicular to the ecliptic plane in the stationary sun frame - stays pointed in the same direction in the moving earth frame.

7.4 *Bradley's interpretation of the aberration of light*

7.4.1 *"Obvious" does not mean always "true"*

Aberration of light phenomenon was discovered by Bradley in 1727 when he found the apparent position of a distant star was altered in consort with the earth's motion around the sun. It is generally believed that the phenomenon of aberration of light could be interpreted, using the corpuscular model of light, as being analogous to the observation of the oblique fall of raindrops by a moving observer.

It is said that Bradley hit upon the correct interpretation of these results during a pleasure trip on the river Thames. Bradley's own words are instructive:

"At last, I conjectured that all the phenomena hitherto mentioned proceeded from the progressive motion of light and the earth's annular motion in its orbit. For I perceived that, if light was propagated in time, the apparent place of a fixed object would not be the same when the eye is at rest, as when it is moving in any other direction than that of the line passing through the eye and object; and that when the eye is moving in different directions, the apparent place of the object would be different." [17].

What had to be added in the 20th century was that the dynamical laws of Newton for light were found to be all wrong, and electromagnetic wave theory had to be introduced to correct them. The corpuscular theory of light is approximately valid in the case of spatially incoherent light when the scale of things is sufficiently large compared to spatial coherence length .

Today the argument that there is an aberration for rays transmitted through a telescope runs something like this. There is a widespread belief that the discussion of the stellar aberration effect would have been perfectly adequate if the positions of stars were determined with the sort of primitive telescope without focusing system. The "telescope" is just a long hollow cylinder that we aim at the star. Let us examine the reasoning presented in textbooks. To quote Ugarov [14]: "But why does the motion of the observer (telescope) affect the apparent direction of the incident light? This can be explained with the help of a simple example. Let a bead be falling vertically with the uniform velocity c . We want it to pass through a pipe of length l moving horizontally with velocity v without hitting the walls. The way to achieve this is by keeping the pipe axis. Obviously, the pipe should be tilted forward in the direction of motion."

This explanation of the aberration of starlight phenomenon is wrong. In order to detect the aberration effect inside the moving earth frame, it is obvious that some coordinate system with reference direction is needed. For the coordinate system to be of real use, it must be identical to the coordinate system in the stationary sun frame. In astronomy, the aberration direction is determined with reference to the common reference axis. This axis is oriented perpendicular to the ecliptic plane in the stationary sun frame-stays pointed in the same direction in the moving earth frame. The observer motion-induced aberration of the ray beam does not exist at all in the earth-based telescope measurements.

7.4.2 *Disproof of the conventional theory of the aberration of light rays*

Suppose that an observer in the moving earth frame performs an aberration measurement. The moving observer can directly measure the declination angle of the transmitted ray beam using a reference direction which is

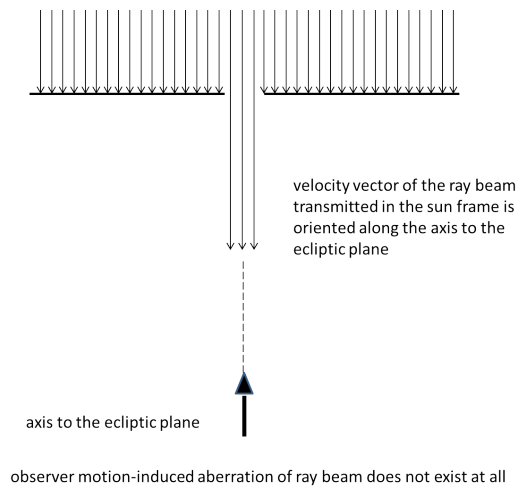

Fig. 16. Measurement of the aberration of light rays inside the frame. The aberration direction (i.e. the direction of ray beam) inside the frame is determined with reference to the fixed spinning axis. This (perpendicular to the ecliptic) axis in the stationary sun frame-stays pointed in the same direction in the moving earth frame. The observer motion-induced aberration of the ray beam does not exist at all.

formed by the spinning axis, Fig. 16. It is assumed, for simplicity, that the declination in the sun frame is equal to zero. In other words, it is assumed that the velocity vector of the transmitted ray beam in the sun frame is oriented along the axis to the plane of the earth's revolution around the sun.

Is it possible to deduce the relative velocity of the frames merely by measuring the angle of the transmitted ray beam inside the moving earth frame? The answer is no. The (perpendicular to the ecliptic) reference axis in the stationary sun frame-stays pointed in the same direction in the moving earth frame. This means that in all experiments performed inside the moving earth frame the declination of transmitted rays will be the same as it would be if the frame were standing still.

Is it possible to deduce the relative velocity of the frames merely by measuring the angle of the transmitted coherent beam inside the frame? The answer is yes. In the coherent limit, the aberration is detectable, if the moving observer does not look outside the frame. The moving observer can directly measure the angular displacement of the transmitted light beam using a reference axis which is oriented perpendicular to the ecliptic, Fig. 17. It is assumed that the velocity vector of the transmitted coherent beam in the sun frame is oriented along the axis to the plane of the earth's revolution around the sun. The moving observer would find that the direction of the propagation of the transmitted light beam is altered in consort with the lab frame motion with respect to his frame.

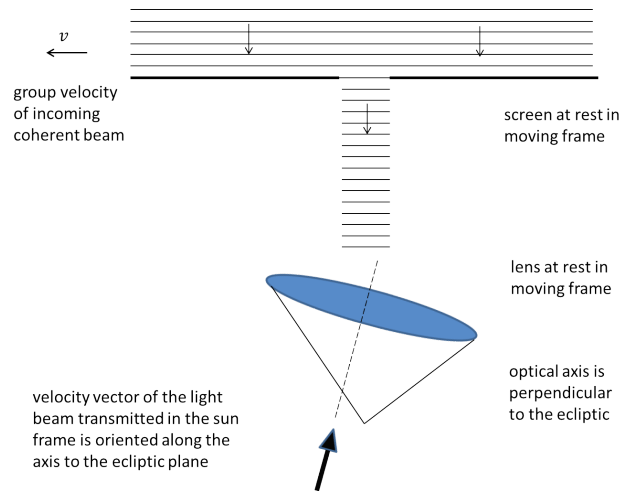

Fig. 17. Measurement inside the moving earth frame in the coherent limit. A lens is at rest in the moving frame and its optical axis is directed along the axis that is perpendicular to the ecliptic plane. The transmitted light beam is imaged by a lens. There is the displacement from the original position on the optical axis of a light spot in the focal plane of the imaging lens. This is because the propagation direction of the light beam transmitted in the sun frame is directed along the axis to the plane of the earth's revolution around the sun.

7.5 What is a referential direction in the conventional aberration of light theory?

A conventional approach to the aberration of light rays has been used for nearly 300 years. However, the type of physical procedure which provides the reference direction inside the moving frame has never been analyzed in literature. We must emphasize that the described in textbooks aberration of light experiment is fundamentally different to the procedure of stellar aberration measurement. What was overlooked was that the measurements of stellar aberration is based on the use of physical coordinate system in space for moving earth-based frame which is identical to the coordinate system in the stationary sun frame. In astronomy, the aberration direction inside the earth-based frame is determined with reference to the fixed spinning axis of a gyroscope. In fact, the earth's revolution about the sun can be considered as an enormous gyroscope. The axis (perpendicular to the ecliptic) in the stationary sun frame -stays pointed in the same direction in the moving earth frame. In the case of astronomic procedure of the aberration of light measurements, the observer motion-induced aberration of a ray beam does not exist at all.

From the conventional aberration of light rays theory it follows that the moving telescope must be angled forward into a "shower" of light rays. It remains an interesting question of principle whether or not the aberration of light rays can be observed through an experiment described in textbooks.

The question cannot be avoided relative to what are light rays propagated in the moving frame with angular displacement v/c ? It is obvious that some coordinate system with reference direction is needed. In order to detect the aberration effect inside the moving frame, we must inquire in detail by what method we assign coordinates. This method involves some sort of physical procedure.

Let us try to get an understanding of the relationship between the lab space reference direction and the reference direction inside the moving frame. A conventional approach to the aberration of light effect is forcefully based on a definite assumption of reference direction, but this is actually a hidden assumption. As a matter of fact, the authors of textbooks constantly use a local physical reference frame as a hidden assumption in their conventional description of the aberration of light phenomenon.

Such approach is actually based on the use of local reference light sources. We determine the reference direction in the lab frame and in the moving frame using two local light sources. In effect, one source should stay at rest in the lab frame while the second should be at rest in the moving frame. In other words, the reference axis in each frame is formed by an individual light beam.

It must be added to the above consideration that the procedure described above provides necessary conditions to the behaviour of local space coordinate systems. We may in fact denote a local coordinate system, for instance, as a rigid body (in this case, the coordinates have a direct interpretation in terms of comoving rigid bodies). Indeed, using measuring rods alleged to be rigid, we can determine coordinate vectors. Location is specified relative to a set of objects that have no relative motion between them. Our most familiar (textbook) example is a railway platform and a moving railway car. The equivalence of all local physical frames of reference underlies the theory of relativity, so when the aberration angle emerges, it emerges in the same manner in all local physical reference systems.

It is important to remark here that from a fundamental point of view it is unsatisfactory to interpret referential directions via measuring procedures with complicated macroscopic rods. This could create the false impression that rods are basic entities without which the theory would have no physical content. It is clear that rods themselves consist of more fundamental entities. In principle it would therefore be better to base the interpretation of the theory directly on what it says about the fundamental constituents of matter. Fortunately, it is possible to found the space description on a more fundamental level than that of macroscopic measuring rods. In fact, a referential directions in the local frame can be physically realized by light beams.

Now, how about the aberration of light rays? The choice of coordinates is conventional and pragmatic. It is mentioned above that traditionally the physical interpretation of the aberration of light effect in terms of measurements performed with rods that are at rest in the observer's frame. This (local frame of reference) convention is self-evident and this is the reason why it is never discussed in the aberration of light theory ⁹.

In the case of local frame of reference, one will experience the observer motion-induced aberration of the ray beam phenomena. When the aberration of rays measurement will be performed, the both observers would find that the moving telescope must be angled forward into a "shower" of light rays. In fact, the motion of the light source will result in an apparent change of the reference light beam declination by an amount v/c . The moving observer will interpret this change inside his frame as a change in the ray beam angular position. The lab observer will find no change inside his frame. Now we will assume that the lab observer will look outside. The lab observer would find that the direction of ray beam propagation in the moving frame is the same, but the direction of propagation of the referential light beam is altered in consort with the referential source motion with respect to the lab frame. Then, when the measurement of the moving observer is analyzed, the lab observer finds that the measured aberration angle in the moving frame is nonzero and consistent with moving observer measurement.

It should be note that it is not strictly necessary to specify the location relative to a set of objects that have no relative motion between them. In this paper we discuss an astronomical approach that does not make use of local reference frame. The traditional (for astronomy) link between the aberration of starlight and physical concepts makes use of reference axis which is oriented perpendicular to the ecliptic plane. Due to particular choice of space coordinates, the observer motion-induced aberration of rays does not exist in the earth-based (telescope) measurements.

⁹ It should be note that we also used above this traditional convention. In fact, a conventional graphical referential frame is actually formed in the previous sections (see e.g. Fig. 1,2) by rigid body. In this case, the coordinates have a direct interpretation in terms of comoving rigid rods.

8 Stellar aberration and relativity

8.1 *The conventional interpretation*

The result given in Section 6 is correct for a variety of screen hole geometries. For instance there exist the deviation of the energy transport in the case of moving open end of the telescope barrel. All authors treat light propagating through the telescope barrel as rays (i.e. as raindrops) not as a coherent wavefront. Today one is told that wavefronts and rays are to have the same aberration.

Fig.18 presents the overall geometry of a typical aberration experiment with a telescope. For an observer on the earth, it is, with respect to the solar referential frame, of 30 km/s, corresponding to the earth motion around the sun. Clearly, if the earth always moved with the same velocity then the phenomenon would not be detectable because the entire sky would be displaced in a permanent way, hence it would be impossible to notice such displacement. However, vector velocity changes in the course of the year: the earth moves around the sun, with consequence change of the direction of velocity.

To quote Norton [9]: "... we recover the effect of aberration by a widely known analysis depicted in Figure 6. It takes the case of a star positioned perpendicular to the motion of the earth. If the telescope were pointed directly at the star, starlight entering the end of the telescope would be unable to pass its full length. Since the telescope tube is moving perpendicular to the direction of propagation of the light, the trailing wall of the telescope would move into the path of the light stop it reaching the eyepiece. ... The expedient that makes it possible for the light to reach the eyepiece is to tilt the telescope in the direction of motion of the earth. Then—as Figure 6 shows—the trailing wall never intercepts the light scooped up by the telescope opening as the telescope moves across the path of light propagation. The starlight propagates to the eyepiece. The familiar analogy is to a tall, upwardly pointing hat used to catch rain in a vertical rain shower by a runner running through it. The hat must be tilted if the rain is to pass through the opening of the hat to wet the bottom. It turns out the above rule for computing the aberration angle gives exactly the angle through which the telescope tube must be tilted to ensure that the starlight passes through to the eyepiece."

This typical interpretation of the phenomenon called "Bradley's aberration" is wrong. The observer motion-induced aberration of the ray beam does not exist at all. Bradley's original paper got the interpretation by an incorrect

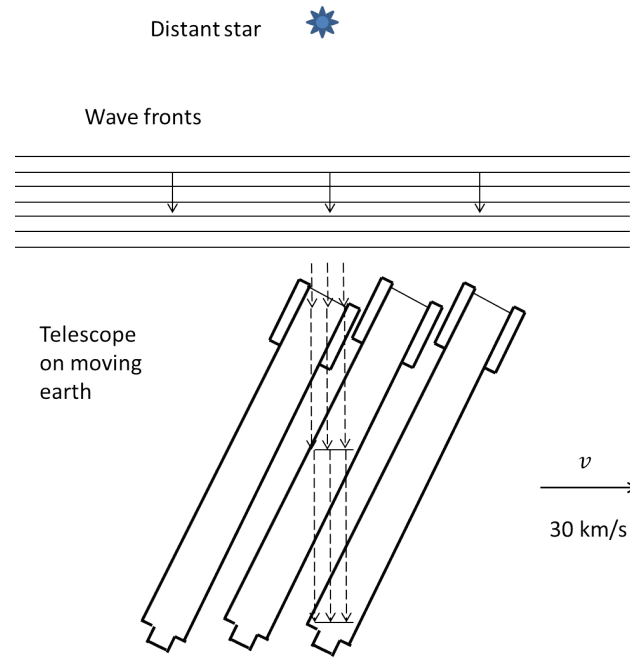

Fig. 18. Typical interpretation of stellar aberration in the conventional (oblique) theory. Norton visualized this situation by help of his Fig. 6 in [9] which we reproduce here.

physical argument. Above we illustrated that this wrong argument persists to this day. Questioning the validity of Bradley's reasoning we argue that a satisfactory treatment of stellar aberration should be based on the relativistic coherent wave optics and an astronomical reference system.

8.2 Statistical phenomena in optical astronomy

Before we proceed with our study of how the stellar aberration comes about, we should understand that a star is a spatially incoherent source. The character of the mutual intensity function produced by an incoherent source is fully described by the Van Cittert-Zernike theorem [15]. Note that the star is very far away from the earth. In all cases of practical interest, the telescopes are situated in the far-zone of the (distant star) source. Under these circumstances, the Van Cittert-Zernike theorem takes the simplest form. It is the source linear dimension d (star diameter) that determines the coherent area of the observed wave $zc/(\omega d)$, where z is the distance between the source and the observer.

The meaning of spatial coherence can best be understood with the help of Young's two pinhole experiment. In the elementary sense, the degree of coherence between the two points simply describes the contrast of the interference fringes that are obtained when the two points are taken as

secondary sources. Coherence effects can also be observed in a less direct interferometric instrument known as intensity interferometer. Such an instrument, first conceived and demonstrated by Brown and Twiss, requires the use of coherence of order higher than 2 for the understanding of its operation.

It can be easily demonstrated that the light produced by a distant star is approximately coherent over a circular area on the earth's surface, whose diameter in all practical cases is much larger than the telescope diameter. Consider a star like Sirius which is the nearest object. The coherent area of light observed from Sirius has a diameter of about 6 m. This correlation was observed by Brown and Twiss in 1956 [16]. In 1727, the astronomer Bradley had measured the stellar aberration, an annular variation of the apparent position of stars on the celestial sphere, using a simple telescope. The star he chose was Draconis which is also one of the nearest stars. In this case the diameter of the coherent area on the earth's surface can be estimated about 100 m. Hence, we sample such a tiny portion of the coherent area of the starlight with our telescopes that the waveforms are effectively (flat) plane waves. The starlight entering the end of the telescope includes only information about the angular star position (with respect to the telescope axis). This information is recorded in the tilt of the flat phase front which is passed along the barrel of the telescope.

We would like now to discuss the region of applicability of ray optics in the theory of the aberration of light. The ray analysis in the optical astronomy gives the right answer in the case when the relevant spatial coherence length of the astronomical light source on the earth's surface is much shorter than the telescope diameter. One of these cases is the light from the solar system planets. In this situation one can use a geometrical optics approach in order to solve the image formation problem. In particular, the direction of the light propagation through the telescope barrel can be found with the help of geometrical optics considerations. By a site abuse of language, it can be said that each ray has a finite thickness which is the same order as spatial coherence length of the light entering the end of the telescope.

8.3 *Wave theory of the aberration of starlight*

8.3.1 *Distant star in motion. The solution to the binary-star "paradox"*

It is generally believed that the theory of relativity appears to conform to the phenomenon of stellar aberration discovered by Bradley by claiming it is a consequence of the motion of observers relative to light sources, but binary stars do not exhibit such shifts when traversing our direction of

view¹⁰. Therefore, there appeared to be a serious problem where the motion of emitters relative to observers did not seem to produce the same effects as the motion of observers relative to emitters. We resolved this difficulty by noting that when the light passes through the end of telescope barrel we have a light beam whose fields has been perturbed by diffraction, and now not include information about emitter motion. The stellar aberration is considered independent of the source speed and to have just a local origin exclusively based on the observer speed.

Above in Section 6, we demonstrated that when one has some hole in the opaque screen at rest and the size of the hole is very small relative to the size of the transversely moving "plane-wave" emitter, there is no aberration (deviation of the energy transport) for light transmitted through the hole. The absence of the effects of moving source in this setup automatically implies the same problem for stellar aberration theory. How shall we solve it? It is like a hole-emitter problem with the end of the telescope barrel as a hole and with the "ray" of starlight as the light beam from the "plane-wave" emitter. The transverse size of the starlight "ray" is of order to the spatial coherence length on the earth's surface. Since the coherence length of the starlight is much longer than the diameter of the telescope we can, therefore, enforce the small aperture approximation.

Suppose that an observer, which is at rest relative to the telescope, performs the direction of the energy transport measurement. At close look at the physics of this subject shows that in the frame, where the telescope is at rest, we have actually the problem of steady-state transmission. Then how does the transmitted light beam look? It looks as though the transmitted beam is going along the telescope axis because it has lost its horizontal group velocity component. That is the transmission appears as shown in Fig.19. It takes the case of a telescope positioned perpendicular to the plane phase front. In other words, the telescope pointed directly at the star. If the motion of the star is parallel to the phase front (i.e. perpendicular to the telescope axis), starlight entering the end of the telescope would be able to pass its full length.

¹⁰ There are double star systems the components of which change their velocity on a time scale ranging from days to years. Spectroscopic binaries have velocities exceeding the earth's velocity round the sun. They revolve around their common center of gravity within days, a period during which the motion of the earth is practically constant. The components of the binary system should be easily separable, when their changing velocities are comparable to the earth's velocity round the sun. This is, however, not observed. The binary components remain unresolved which means that their velocity has no influence on aberration. Rotating binary systems follow the same pattern as all fixed stars and are observed within a period of a year under the same universal aberration angle, i.e. their apparent position changes with an annual period common to all distant stars.

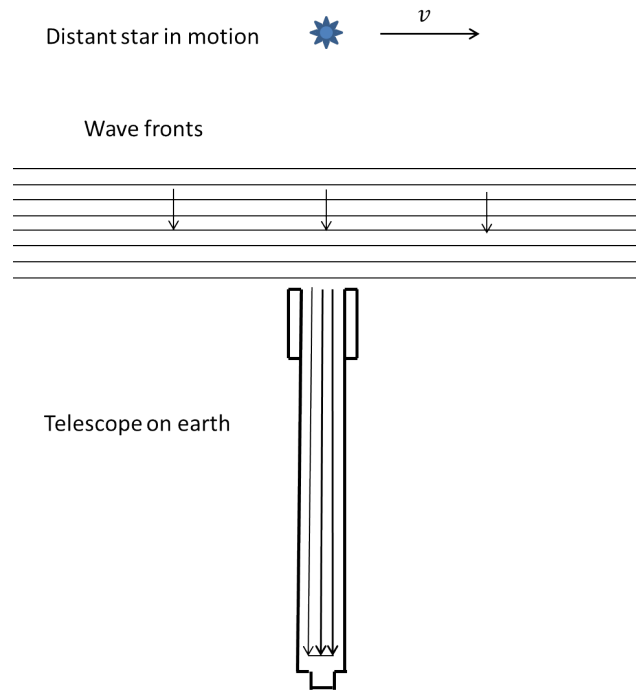
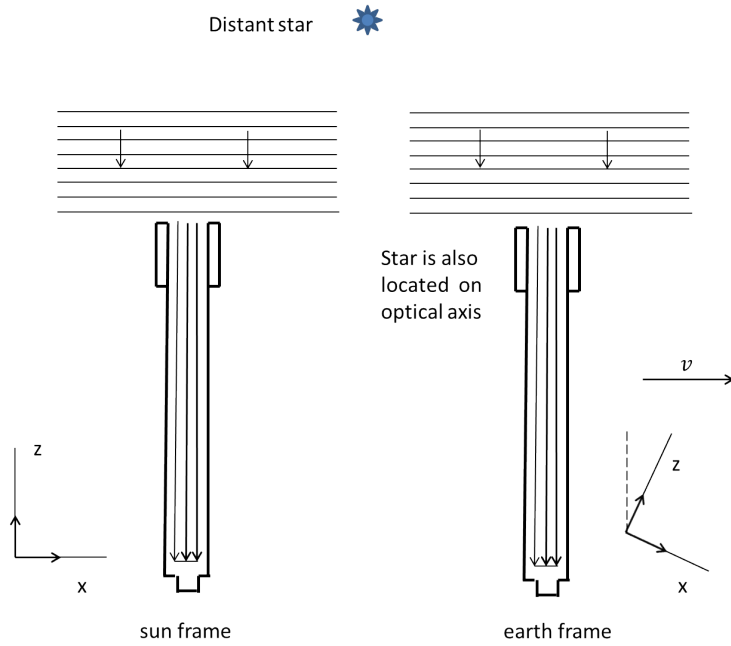

Fig. 19. A telescope is at rest and star moves parallel to the wavefronts. In this case, the coherent wave optics predicts that the motion of the star would have no influence on the actual observation. In particular, rotating binary systems follow the same pattern as all fixed stars and are observed within a period of a year under the same universal aberration angle common to all distant stars.

We shall now discuss the situation where the transverse size of the starlight rays is very small relative to the transverse size of the telescope barrel. It should be noted that this situation is not realized in the earth-based stellar aberration measurement. We shall work out this case in order to understand all the physical principles very clearly. Then how does the rays transmission through the telescope barrel look? We have said before that the aberration of ray source is unsymmetrical with respect to the velocities of observer and source. The aberration of ray source is considered independent of the observer velocity and to have just exclusively based on the source velocity. As one of the consequences of the Doppler effect, we find the group velocity of the light rays radiated off a moving star. This is plausible if one keeps in mind that each ray represents a certain amount of electromagnetic energy, and that energy, like mass, is a conserved quantity, so that a light ray in many respects will resemble a material particle.

8.3.2 *Telescope on moving earth*

In this section, we will try to understand what goes on in two reference frames: one fixed with respect to the sun, and one fixed with respect to the earth. We will call the first frame S and the second E . Consider a "distant"



points is needed. For the coordinate system to be of real use, it must be identical to the coordinate system in the frame S . Suppose that an observer in the moving frame E performs the direction of the same star measurement and the plane wavefront of starlight entering the earth-based telescope is imaged by the lens to a diffraction spot which lies in the focal plane on the optical axis. In other words, the moving telescope is also pointed directly at the star. Measurement of the direction of the telescope axis with respect to the (E) frame axes determines the position of the star on the celestial sphere. The direction of a star as seen from the earth is not the same as the direction when viewed by a hypothetical observer at the sun center.

The rule for computing the angular displacement is very simple. One takes the velocity of light with respect to the stationary frame S , and adds vectorially to it the velocity of the earth with respect to the stationary frame S . The direction of the resulting vector is the apparent direction of the starlight as measured on the earth. The "angle of aberration" is the difference between the true position of the star on the celestial sphere (i.e the position which is measured in the stationary frame S) and apparent position which is measured in the moving frame E as shown in Fig.20. What turns out to be especially interesting is how this result was calculated in the context of a coherent wave theory.

When the earth-based telescope moves with velocity v in the stationary frame S , the Doppler effect predicts a group velocity of the light beam scooped up by the telescope opening. Now the question is, what would the velocity of the entering light beam look like in the frame S ? In order to get the velocity as seen by the observer in the stationary frame S , the tangential (group) velocity of the imaging light beam must be included in the addition of velocities, so the angular displacement of the light beam propagating along the moving telescope axis will be v/c .

We derived the results for observables with the help of Galilean transformations. According to the absolute time coordinatization, the orientation of the radiation phase front remains unvaried. At first sight, if the telescopes were pointed directly at the star they have optical axes parallel to each other. Since there exist the angular displacement of the light beam propagating along the moving telescope axis, the situation seems paradoxical.

We have already discussed that the orientation of the radiation phase front is not a real observable effect. The statement that the phase front orientation has objective meaning to within a certain accuracy can be visualized by the picture of phase front in the proper orientation with angle extension (blurring) given by $\Delta\theta = v/c$. The phase front orientation has no exact objective meaning since, due to the finiteness of the speed of light, we cannot specify any experimental method by which this orientation could

be ascertained. Suppose that an observer in the moving frame performs a phase front orientation measurement. The stationary observer sees that the moving observer performs the measurement. Then when this measurement is analyzed, the stationary observer finds that there is $\Delta\theta = v/c$ uncertainty about the orientation of the phase front of the light beam in the moving frame due to the relativity of simultaneity. This is the key to the "paradox" discussed here. In contrast, the direction of radiation energy propagation has obviously an exact objective meaning.

There is a question that we shall try to answer: since the phase front orientation does not exist as physical reality within angle interval v/c , why do we need to account for the exact phase front orientation in our electrodynamics calculations? When the evolution of the radiation beam is treated according to the absolute time coordinatization, one will experience that phase front orientation remains unvaried: this has no objective meaning but is used in the analysis of the electrodynamics problem. A comparison with a gauge transformation in Maxwell's electrodynamics might help here. Even if the phenomena are quite different, the common mathematical formulation permits us to draw analogues. There is a reason in favor of using potentials: there are situations where it seems simpler to solve equations for potentials ϕ and \vec{A} and derive from them the observable (gauge-invariant) fields rather than to solve Maxwell's equations for the observable fields. Depending on the choice of gauge transformation of the electrodynamics potentials one has different equations. The final result of calculations (i.e. observable fields) does not change, but potentials and electrodynamics equations do, depending on the choice of gauge.

8.3.3 *Conventional rule for computing the angular displacement*

The two interpretation of the stellar aberration effect are shown in Fig.21 and Fig.22. They are obviously distinguishable. It has been shown in the present treatment that the wave optics approach to star aberration theory leads to a substantially different result for energy transport along the telescope barrel than the predicted by the conventional (obliquity) theory. Clearly, the angular displacement of the light beam propagation along the moving telescope axis in the conventional theory compared with the prediction of the wave theory differs in sign. In no way to the two quantitatively different expressions for the aberration of starlight lead to the same result in the same frame of reference. The conventional (obliquity) theory of the stellar aberration is incorrect and therefore not a valid basis to interpret the experimental Bradley's results. Only on the basis of wave theory, we are able to derive the correct sign of the aberration shift in the star's declination.

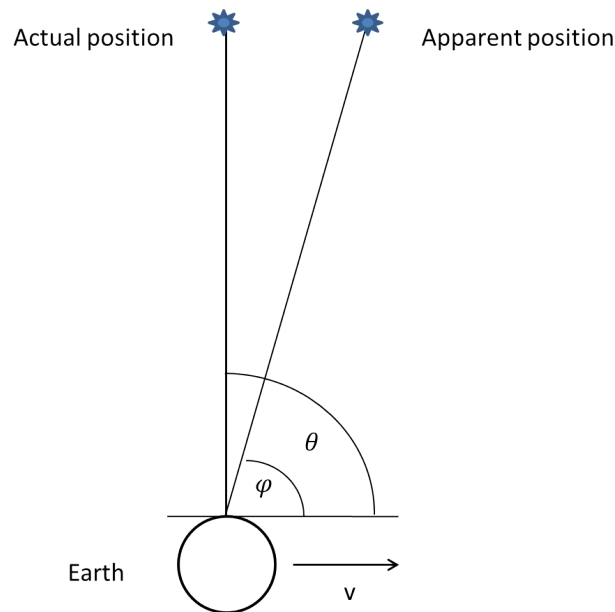

Fig. 21. Telescope on moving earth. Prediction of the conventional (obliquity) theory. The direction of a star as seen from the earth is not the same as the direction when viewed by a hypothetical observer at the sun center. Apparent angle ϕ is less than the actual angle θ . The difference between the actual angle and apparent angle is connected with the physical parameters by the relation: $\theta - \phi = v/c$, where v is the velocity of the earth in its orbit around the sun.

8.4 Bradley's experimental result and its interpretation based on our theory

In 1727, the astronomer Bradley had measured the stellar aberration. Bradley discovered the aberration while he was trying to measure the parallax of the star γ Draconis. Bradley's attempt to measure stellar parallax was without success, but he did make stellar aberration discovery.

The stellar parallax is the change of the direction of observation of a star when it is watched from points of the orbit. The direction of a star as seen from the earth is not the same as the direction when viewed by a hypothetical observer at the sun center. As the earth moves in its orbit around the sun, the geocentric direction (the star position on a geocentric celestial sphere) changes and traces out what is called the parallactic ellipse. The projection of the parallactic ellipse on the celestial sphere is shown in Fig.23. Bradley expected that he would obtain a series of readings for the star declination of the follows form. Expected declination should be $(\delta - q, \delta, \delta + q, \delta)$ on 21st December, 21st March, 21st June, and 21st September respectively [17].

Bradley did indeed find a small shift in the star's declination. It was oscillatory with a period of one year, the measured declinations were $(\delta, \delta - q, \delta, \delta + q)$ on 21st December, 21st March, 21st June, and 21st September respectively,

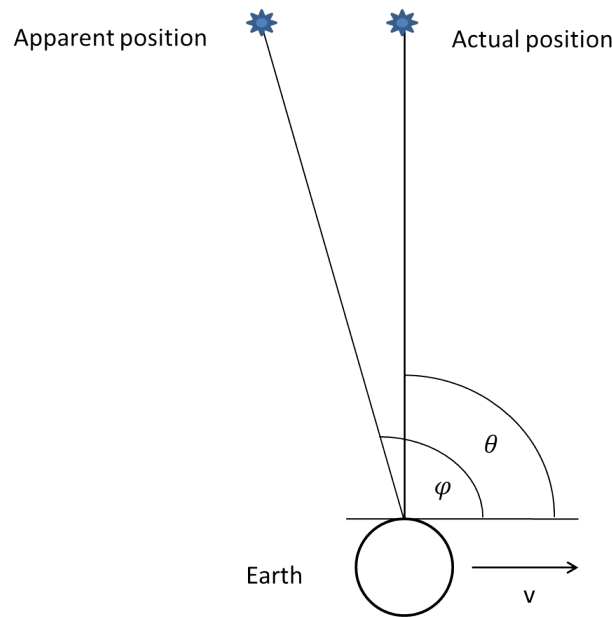

Fig. 22. Telescope on moving earth. Prediction of our theory of the stellar aberration. The direction of a star as seen from the earth is not the same as the direction when viewed by a hypothetical observer at the sun center. The actual angle θ is less than apparent angle ϕ . The difference between the apparent angle and actual angle is connected with the physical parameters by the relation: $\phi - \theta = v/c$, where v is the velocity of the earth in its orbit around the sun.

with $q = 20''$ [17]. As can be seen, however, the expected and observed declinations were three months out of phase with each other. When we examine the experimental results, we see that the expected (parallactic) changes in the star's declinations always "lag behind" the experimental changes, which is in complete agreement with the prediction of our stellar aberration theory. The two phenomena are illustrated in Fig. 23, parallax on the left, aberration on the right. The arrows labeled 1 through 4 represent the earth's velocity at the points of the earth's orbit labeled 1 through 4 in the drawing on the left. Comparing the annual variation in the apparent direction of the star on the left and the right, one sees immediately that the variation on the left lags behind the variation one would expect on the basis of our theory.

Above we have shown that relativistic wave optics predicts an effect of stellar aberration in complete contrast to the conventional treatment. Namely, the aberration shift in the conventional (obliquity) theory compared with the prediction of our theory differs in sign (see Fig.21 and Fig.22). The authors of textbooks believe that the aberration shift in the star's declination periodically varies in time in accordance with the conventional theory prediction. They also should conclude that the aberration changes in the star's declinations "lag behind" the parallax changes. In fact, the expected aberration shift in the conventional theory should be $(\delta, \delta + q, \delta, \delta - q)$ on 21st December, 21st March, 21st June, and 21st September respectively (see Fig.24). The experi-

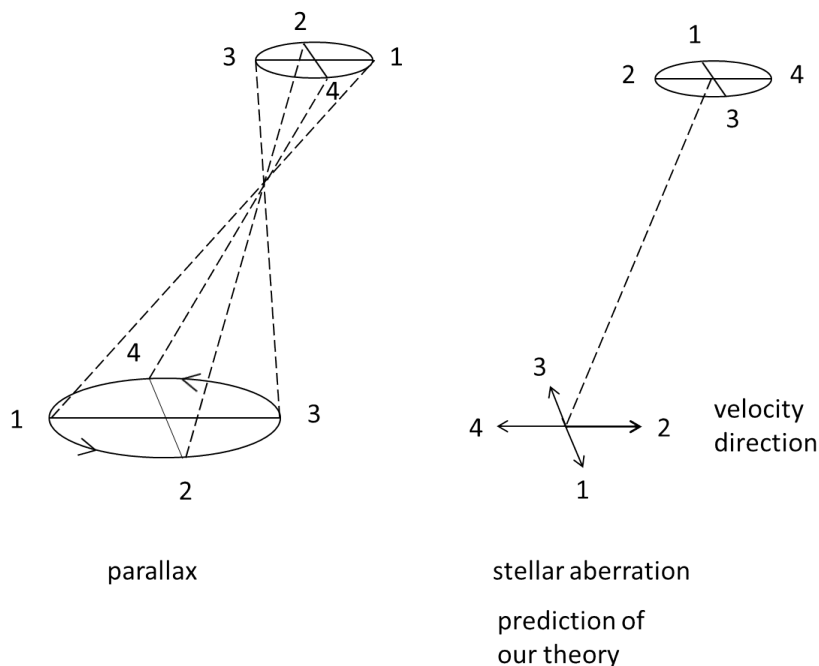

Fig. 23. Telescope on moving earth. Prediction of our theory of stellar aberration. The arrows labeled 1 through 4 represent the earth's velocity at the points of the earth's orbit labeled 1 through 4 in the drawing on the left. The parallax changes in the star's declinations lag behind the aberration changes. The experiment clearly demonstrates that this prediction of our theory is correct.

ments clearly demonstrate that this prediction of the conventional theory is incorrect. As far as we know, this contradiction between the conventional treatment of the stellar aberration and the experimental data has never been discussed in the literature.

A false analogy between the obliquity of light rays and the stellar aberration is discussed in every textbook on astronomy (see e.g. [17]). Despite this comparison of the conventional theory prediction (that the aberration changes in the star's declinations "lag behind" the parallax changes) and experimental data apparently never been presented. We have only been able to find one publication that does have the analysis of the conventional (obliquity) theory prediction, and that is "The Optics and Electrodynamics of Moving Bodies" by Janssen and Stachel [18]. To quote Janssen and Stachel: "The two phenomena are illustrated in Fig. 1, parallax on the left, aberration on the right. ... Comparing the annular variation in the apparent direction of the star on the left and the right, one sees immediately that the variation on the right cannot be due to parallax. The variation on the right lags behind the variation one would expect on the basis of parallax by roughly three months. The phenomenon can readily be understood on the basis of the then-prevailing Newtonian ballistic theory of light. To this day it is, in fact, routinely explained with the help of an analogy this suggests." Surprisingly,

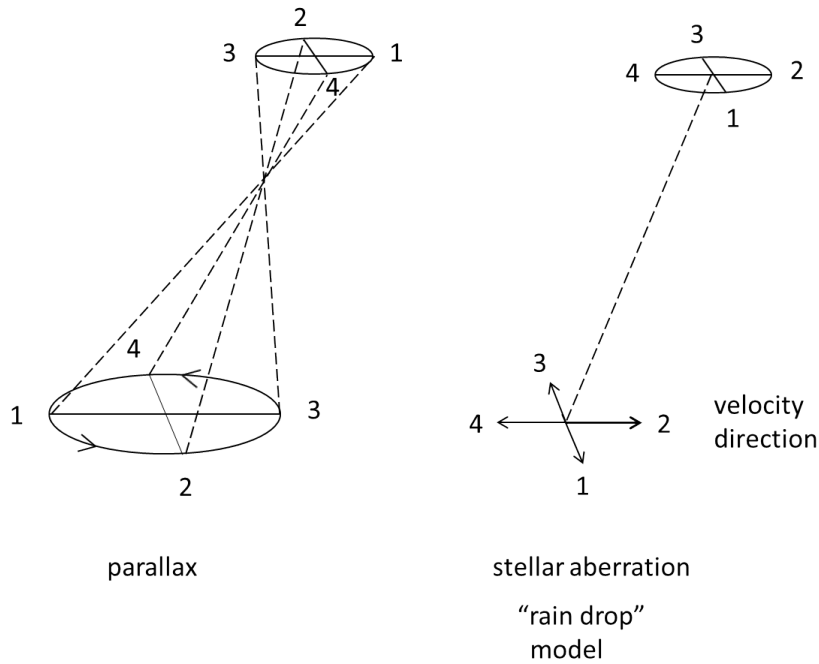

Fig. 24. Telescope on moving earth. Prediction of the conventional (obliquity) theory. The aberration changes in the star's declinations lag behind the parallax changes. Janssen and Stachel visualized this situation by the help of their Fig. 1 in [18] which we reproduce here. This clearly contradicts the experimental observations.

it was not recognized in the literature that this prediction clearly contradicts the experimental observations.

9 Conclusions

The phenomenon of aberration of light is by no means simple to describe, even in the first order in v/c : a large number of incorrect results can be found in the literature. Questions related to reflection of light from transversely moving mirror (or transmission through the transversely moving end of a telescope barrel) lead to serious misunderstanding, which is actually due to an inadequate understanding of several complicated aspects of the theory of relativity, among which is the aberration of light.

The established way of looking at special relativity is based on Einstein postulates: the principle of relativity and the constancy of the velocity of light. According to such limiting understanding of the theory of relativity it is assumed that only Lorentz transformations must be used to map the coordinates of events between inertial observers. Einstein's approach, as we have mentioned before, fails to predict the deviation of the energy transport

for light reflected from a transversely moving mirror. Now we can see the reason.

From the viewpoint of electrodynamics, mirror and emitter are an entangled system. How can we solve a problem involving the emitter-mirror relative velocity? Each physical phenomenon occurs in space and time. A concrete method for representing space and time is a frame of reference (coordinate-time grid), which requires careful description. We can prepare, for mirror and emitter, a common set of synchronized clocks in the lab frame only in the case of absolute time coordinatization i.e in the case when simultaneity is absolute. According to the choice of absolute time coordinatization, the lab observer actually sees the radiation beam after the reflection as a result of a Galilean boost rather than a Lorentz boost.

An analysis of the reason why authors of famous textbooks obtained an incorrect result for the aberration of light from a transversely moving mirror is the focus of this paper. As shown, the mistake of acknowledged experts on the theory of relativity is not computational, but conceptual in nature.

Today any statement about the correctness of Galilean transformations is considered a sort of "heresy", which is in contrast with the generally accepted way of looking at special relativity of most physicists. The space-time geometric approach and, in particular, operational interpretation of Lorentz and absolute time coordinatizations is not an easy subject. The concepts are a little bewildering at first and their practical utility is not immediately obvious¹². However, if one ever wants to create something new in relativistic physics, a thorough understanding of the clock synchronization procedure is imperative. To this end, reading and pondering Section 2 until familiarity breeds comprehension can be of help.

¹² Indeed, the described method, which is in complete agreement with the theory of relativity (as the theory of space-time with pseudo-Euclidean geometry), can, however, as shown by Lorentz, easily be explained on the basis of the ether theory if we may assume that terms in the second order in v/c are below the accuracy of the experiments.

10 Acknowledgments

We acknowledge many useful discussions with Gianluca Geloni and Vitaly Kocharyan. We are also indebted to Gianluca Geloni and Ruslan Khubbutdinov for carefully reading this manuscript.

References

- [1] G. Geloni, V. Kocharyan and E. Saldin, "Relativity and Accelerator Engineering" DESY 17-143 (2017)
- [2] E. Saldin, "Relativity and Synchrotron radiation: Critical Reexamination of Existing Theory" DESY 18-113 (2018)
- [3] E. Saldin, "Wigner Rotation: Theory and Applications to Practical Relativistic Engineering Problems" DESY 19-047 (2019)
- [4] A. Sommerfeld "Optics" Academic Press Inc., 1954
- [5] C. Moeller, "The Theory of Relativity", Clarendon, 1952
- [6] H. Ives, J. Opt. Soc. Am., 40 (1950)185
- [7] G. Puccini and F. Selleri, Nuovo Cimento, 117 B (2002)283
- [8] F. Selleri, Foundation of Physics, 36 (2006)443
- [9] J. Norton, "The Cambridge Companion to Einstein", Cambridge University press (2014) Edited by M. Jansen and C. Lehner, p72
- [10] H. Erlichson, Am. J. Phys. 53, 1(1985)
- [11] D. Marcuse "Light Transmission Optics", Van Nostrand Reinhold Comp., 1972
- [12] J. Norton, Archive for history of exact science, November 2004 , V 59, pp 45-105
- [13] L. Brillouin "Wave Propagation and Group Velocity", Academic Press, 1960
- [14] V. Ugarov "Special theory of relativity", Mir Publishers, 1979
- [15] J. Goodman, "Statistical Optics", Jon Wiley and Sons, 1985
- [16] R. Brown and R. Twiss, Nature, 178 (1956)1046
- [17] A. Roy and D. Clarke, "Astronomy", Taylor and Francis, 2003
- [18] M. Janssen and J. Stachel, "The optics and Electrodynamics of Moving Bodies" Max Plank Istitute for the History of Science, Preprint 265 (2004).

Appendix. Discussion of spatial coherence

The spatial coherence of a light beam generally has to do with the coherence between two points in the field illuminated by the light source. The meaning of spatial coherence can best be understood with the help of Young's two-pinhole experiment (see Fig.25). In its elementary sense, the degree of coherence between the two points simply describes the contrast of the interference fringes that are obtained when the two points are taken as secondary sources. Let a source S illuminate the two pinholes S_1 and S_2 , as shown in Fig.25. The source is perfectly non-coherent. That is to say, no interference fringes can be obtained by placing two pinholes in the plane of the source. It was shown, however, that if the two pinholes are placed far enough away from the non-coherent source, interference fringes of good contrast can be obtained. It is sometimes said that the spatial coherence in light beams increases with distance "by mere propagation". It would be nice to find an explanation which is elementary in the sense that we can see what is happened physically.

Suppose that a quasi-monochromatic wave is incident on an aperture in an opaque screen, as illustrated in Fig. 25. In general, this wave may be partially coherent. The detailed structure of an optical wave undergoes changes as the wave propagates through space. In a similar fashion, the detailed structure of the spatial coherence undergoes changes, and in this sense, the transverse coherence function is said to propagate. Knowing the spatial coherence on the aperture, we wish to find the spatial coherence on the observing screen at distance z beyond the aperture. The stellar radiation is a stochastic object and for any starlight beam there exist some characteristic linear dimension, Δr , which determines the scale of spatially random fluctuations. Fig.26 illustrates the type of spiky pattern on an aperture in an opaque screen. When $\Delta r \ll d$, the radiation beyond the aperture is partially coherent. This case is shown in Fig.26. Here Δr may be estimated as the typical linear dimension of spikes.

First, we wish to calculate the (instantaneous) intensity distribution observed across a parallel plane at distance z beyond the aperture. The observed intensity distribution can be found from a two-dimensional Fourier transform of the field. The radiation field across the aperture may be presented as a superposition of plane waves, all with the same wavenumber $k = \omega/c$. The value of k_{\perp}/k gives the sin of the angle between the z axis and the direction of propagation of the plane wave. In the paraxial approximation $k_{\perp}/k = \sin \theta \sim \theta$. If the radiation beyond the aperture is partially coherent, a spiky angular spectrum is expected. The nature of the spikes in the angular spectrum is easily described in Fourier-transform notations. We can expect that the typical width of the angular spectrum envelope should be of the order of $(k\Delta)^{-1}$. Also, an angular spectrum of the source having

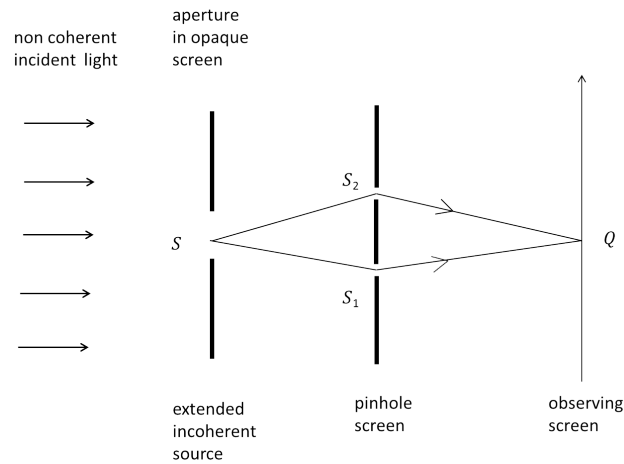

Fig. 25. Young's interferometer.

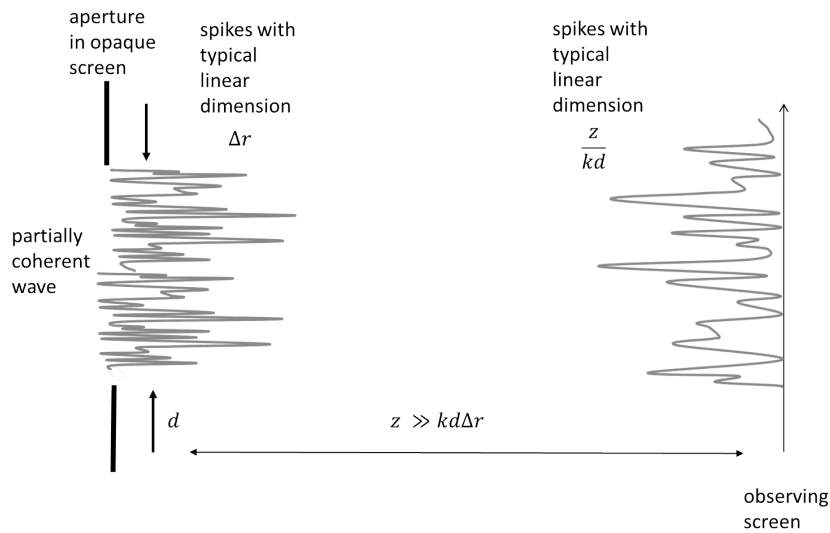

Fig. 26. Geometry for propagation of spatial coherence.

transverse size d should contain spikes with a typical width of about $(kd)^{-1}$, a consequence of the reciprocal width relations of Fourier transform pair (see Fig.27). It is the source linear dimension d that determines the coherent area of the observed wave $z/(kd)$, but in addition, the coherence linear dimension Δr of the source influences the distribution of average intensity over the observing screen with typical width $z/(k\Delta r)$. Thus, if the screen is placed far enough away from the incoherent source, $z \gg d\Delta r/\lambda$, a coherence area of a large linear dimension can be obtained.

A star is an incoherent source with the scale of spatially random fluctuations $\Delta r \sim \lambda$. Such a source emits radiation in all directions. Also, an angular spectrum of the starlight contains spikes with the typical width $(kd)^{-1}$, where d is the star diameter. In the case of astronomical observations by telescope, the coherent area of the observed starlight would be of the order of $z/(kd)$,

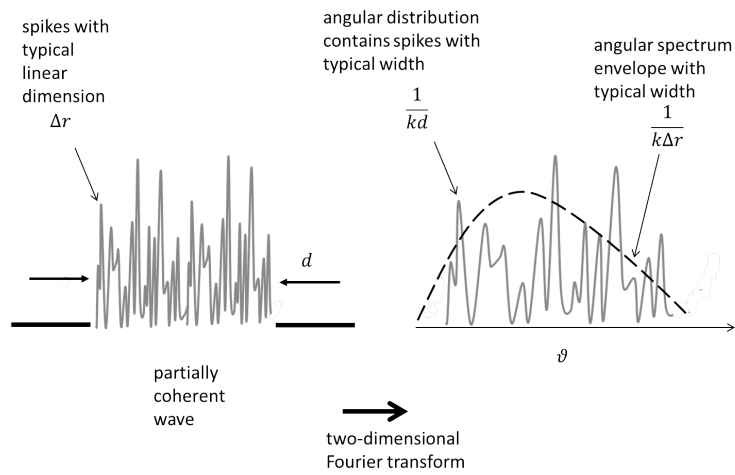

Fig. 27. Reciprocal width relation of Fourier transform pair.

where z is the distance between the star and earth. The coherent area of light observed from the nearest star Sirius has a diameter of about 6 m. Hence, we sample such a tiny portion of the coherent area of the starlight with our telescopes that the waveforms are effectively plane waves. It can be said that each spike on the earth's surface has a finite thickness which is the same order as the spatial coherence length of the starlight. When a star is moving with velocity v in the tangential direction to the phase front these spikes are also moving in the same direction with the group velocity $v_g = v$.