

Electroproduction of  $\rho^0$  mesons

I. Cohen,\* R. Erickson,† F. Messing,‡ E. Nordberg, R. Siemann,  
J. Smith-Kintner, and P. Stein  
Cornell University, Ithaca, New York 14853

A. Sadoff  
Ithaca College, Ithaca, New York 14850

G. Drews, W. Gebert,§ F. Janata, P. Joos, A. Ladage, H. Nagel,§  
H. Preissner,|| and P. Söding  
Institut für Experimentalphysik der Universität Hamburg, Hamburg, Germany  
and Deutsches Elektronen-Synchrotron (DESY), Hamburg, Germany  
(Received 16 September 1981)

Cross sections for  $\rho^0$  electroproduction measured in a streamer-chamber experiment are separated into elastic ( $ep \rightarrow ep\rho^0$ ) and inelastic production channels. For the elastic channel, the total cross section and  $t$  dependence are presented. For the inelastic channel  $(1/\sigma)d\sigma/dz$ ,  $(1/\sigma)d\sigma/dp_T^2$ , and a density matrix element are shown and compared to quark-parton-model predictions. The ratio of  $\rho^0$  to direct  $\pi^0$  production is found to be  $2.0 \pm 0.5 \pm 0.3$ , where the first error is statistical, and the second error is systematic.

I. INTRODUCTION

An analysis of  $\rho^0$  production has been carried out using data from an electroproduction experiment at 11.5-GeV beam energy, performed at the Wilson Synchrotron Laboratory. The apparatus consisted of a streamer chamber with an internal hydrogen target triggered by a scattered electron.

Two different physical mechanisms are thought to contribute to  $\rho^0$  electroproduction: coherent diffractive production, chiefly elastic ( $ep \rightarrow ep\rho^0$ ), and nondiffractive production described in parton models by the fragmentation of a single struck quark.<sup>1-3</sup> For the elastic channel we present measurements up to  $Q^2=4 \text{ GeV}^2$  and compare with previous measurements at lower  $Q^2$ .<sup>2,4-6</sup> The inelastic data are compared with quark-fragmentation models and with results from muoproduction,  $e^+e^-$  annihilation, and antineutrino interactions. A comparison of  $\rho$  production to direct  $\pi$  production is of interest because the  $\rho$  and the  $\pi$  have the same quark content and differ only in quark spin alignment.

II. THE APPARATUS

The main part of the apparatus consisted of a streamer chamber surrounding the liquid-hydrogen

target. This device has a high detection efficiency for all charged secondary particles. For the determination of their momenta a magnetic field of 16.5 kG was applied.

The streamer chamber was triggered by particles scattered into an array of hodoscopes and shower counters placed behind the magnet as shown in Fig. 1. These detectors were designed to be sensitive to the scattered electrons while discriminating against a copious background of hadrons and photons, and were positioned to preferentially accept high- $Q^2$  events. Multiwire proportional chambers positioned in front of the trigger counters were used to improve the momentum resolution for the scattered electrons by extending their measurable

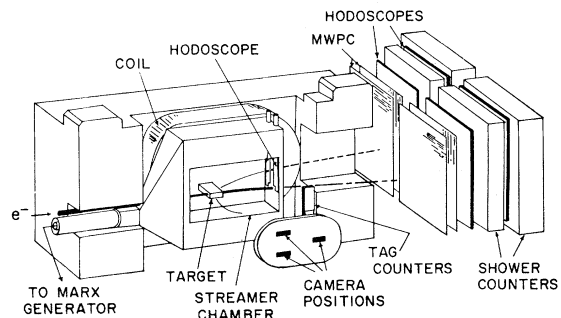

FIG. 1. Schematic layout of the apparatus.

track length beyond the streamer chamber.

We define  $Q^2$ ,  $\nu$ ,  $W$ , and  $x$  ( $\equiv Q^2/2M\nu$ ) in the usual manner;  $z$  is defined to be  $E^h/\nu$ , where  $E^h$  is the laboratory energy of hadron  $h$ .

### III. ELASTIC $\rho^0$ PRODUCTION

To investigate the reaction  $ep \rightarrow ep\rho^0$ , those events satisfying the four-constraint kinematical fit to  $ep \rightarrow ep\pi^+\pi^-$  were separated from the rest of the data. To this ensemble of events a mixture of  $\pi^-\Delta^{++}$ ,  $\pi^+\Delta^0$ ,  $p\rho^0$ , and phase-space contributions was fit, using techniques described by Joos *et al.*<sup>5</sup>

The resulting virtual-photon cross sections are shown in Fig. 2, and are compared with photoproduction and other leptonproduction experiments. The data are normalized to the total cross section as measured by Stein *et al.*<sup>8</sup>

The differential cross section  $d\sigma/dt$  has been determined for  $W > 2.1$  GeV in two intervals of  $Q^2$ . For four-momentum transfers  $-t' = -(t - t_{\min})$  less than  $0.6$  GeV<sup>2</sup>, our data (Fig. 3) show an exponential dependence  $e^{At'}$ . The decrease in  $A$  with increasing  $Q^2$  seen by comparison with other work in Fig. 4 can be interpreted as shrinkage of

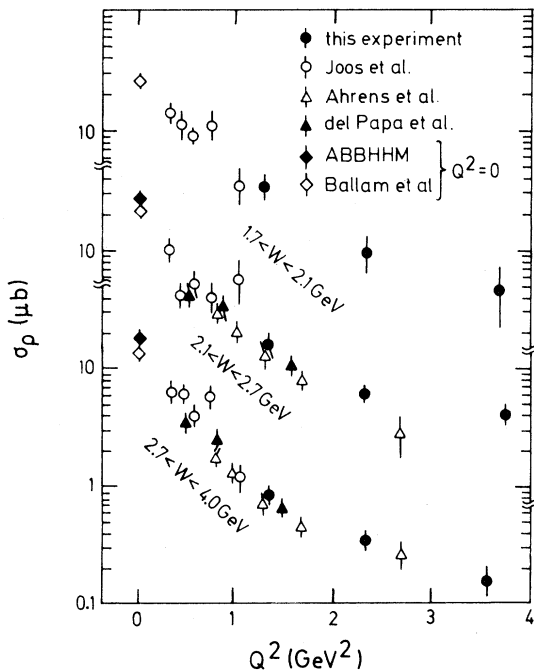

FIG. 2. Cross section for elastic  $\rho^0$  production as a function of  $Q^2$  in three  $W$  regions. The data from Refs. 4–7 are also shown.

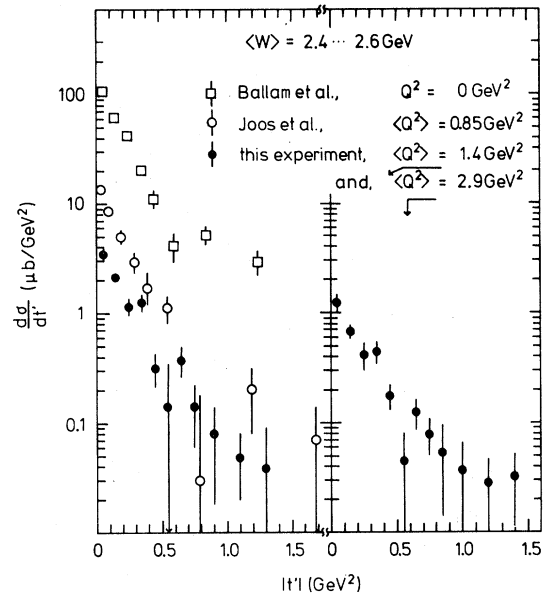

FIG. 3. Distributions of  $t'$  for two regions of  $Q^2$ . Data at lower  $Q^2$  (Ref. 5) and from photoproduction (Ref. 7) are included.

the effective photon-proton interaction radius. In a vector-dominance picture it may be ascribed to insufficient formation time<sup>9</sup> of the virtual  $\rho$ . For our data this formation time

$$t_f \sim 2\nu/(Q^2 + m_\rho^2)$$

is less than  $10 \text{ GeV}^{-1}$ .

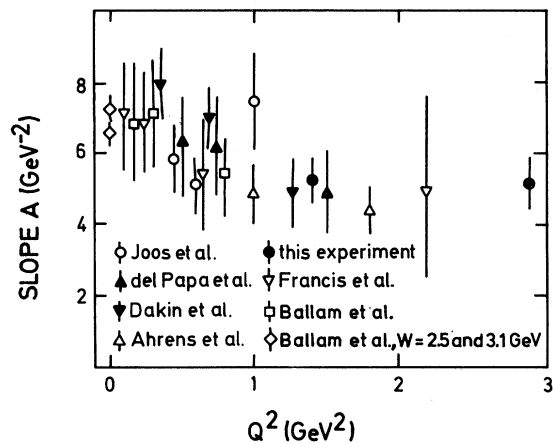

FIG. 4. Slope parameter  $A$  as obtained from least-squares fits of the  $t'$  distribution to  $e^{At'}$  as a function of  $Q^2$ . The data from Refs. 4–7 are included.

#### IV. INELASTIC $\rho^0$ PRODUCTION

For the inelastic part of our data, we present results in terms of quantities which are independent of energy in the quark-fragmentation model. These results are shown for  $z > 0.4$ , in the kinematic region  $1 < Q^2 < 6 \text{ GeV}^2$ ,  $2.8 < W < 4.2 \text{ GeV}$ , and  $x > 0.1$ . The average values of the kinematical quantities are  $\langle Q^2 \rangle = 2.5 \text{ GeV}^2$ ,  $\langle W \rangle = 3.3 \text{ GeV}$ , and  $\langle x \rangle = 0.2$ . Elastic events were removed from the sample.

To determine the  $z$  dependence of the  $\rho^0$  cross section, the invariant mass and  $z$  for each oppositely charged hadron pair were calculated, assuming each hadron to be a pion. The invariant mass distribution of pairs with  $z > 0.4$  is shown in Fig. 5. In each  $z$  bin, the mass distribution was fitted to a five-term Laurent series plus a Breit-Wigner function with mass and width 0.773 and 0.150 GeV, respectively. The integral of the Breit-Wigner was assumed to be the number of  $\rho^0$  mesons.

The average  $\chi^2$  for these fits was 49 for 44 degrees of freedom. The sensitivity of the results to the various assumptions in the analysis procedure was investigated. Other background parametrizations were used, including estimated contributions from  $\Delta^0$ ,  $\omega$ ,  $K^*$ , and  $\eta$  production. Several forms of the Breit-Wigner function were tried. In all cases the results changed by less than 10%. Corrections for lost tracks (10–15%) and radiative effects ( $\sim 20\%$ ) were applied, both of which exhibited a slight  $z$  dependence.

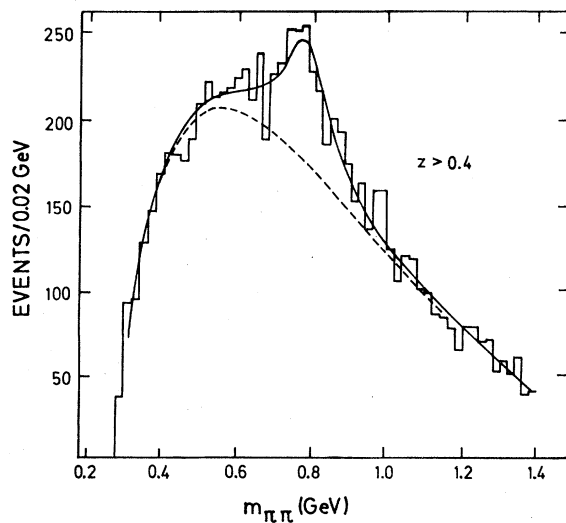

FIG. 5.  $\pi^+\pi^-$  mass distribution after removal of the elastic events. The curves were determined by the fitting procedure described in the text.

The quark-parton model<sup>10</sup> relates the distribution of the cross section in  $z$  to the distribution of quarks in the proton and the quark fragmentation functions. From the symmetry of the quark content of the  $\rho^0$  and the paucity of strange quarks in the proton,<sup>11,12</sup> it follows that

$$\frac{1}{\sigma_{\text{tot}}(x)} \frac{d\sigma^{\rho^0}}{dz}(x,z) = D_u^{\rho^0}(z) = D_d^{\rho^0}(z).$$

This result applies to electroproduction, muoproduction, and, except for strange-quark production, to antineutrino charged-current interactions, and to  $e^+e^-$  annihilation, and thus permits direct comparisons of data. It should be noted, however, that the model itself is not considered useful at low  $z$ .

In Fig. 6, we present our data as well as results from other experiments,<sup>13–15</sup> and compare with two models of quark fragmentation. Our data agree in shape with the model of Field and Feynman.<sup>1</sup> The muoproduction point at the highest  $z$  cannot be compared with the other measurements since the elastic channel was not subtracted from the data. The  $e^+e^-$  data have been divided by two since there are two leading quarks in this process. The agreement of data from different processes lends support to the universal applicability of the quark-parton model.

The dependence of the cross section on  $p_T$ , the transverse momentum with respect to the virtual

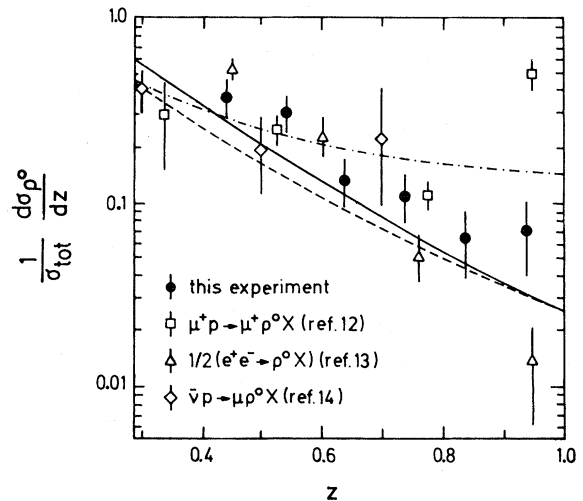

FIG. 6.  $z$  distribution of the  $\rho^0$  cross section shown in comparison with other experimental results and with the fragmentation function  $D_u^{\rho^0}$  from Field and Feynman (Ref. 1) including  $\eta'$  production (solid curve) and without  $\eta'$  (dashed curve), and from Andersson *et al.* (Ref. 3) without  $\eta'$  production (dashed-dotted curve).

photon's direction, was determined for those pairs with  $z > 0.4$  in a manner similar to that described above. The results shown in Fig. 7 are in good agreement with a single exponential in  $p_T^2$  with  $\langle p_T \rangle = 0.51 \pm 0.03$  GeV. This value is similar to our results for inclusive high- $z$  hadron<sup>16</sup> ( $\langle p_T \rangle = 0.46$  GeV) and  $K_S^0$  (Ref. 17) ( $\langle p_T \rangle = 0.43 \pm 0.03$  GeV) production and also to results from  $\pi^+ p \rightarrow \rho^0 X$ .<sup>18</sup>

The helicity-zero contribution to inelastic  $\rho^0$  production  $\rho_{00}$  was measured by analyzing the  $\rho^0$  decay pion angular distribution. This distribution is

$$W(\cos\theta) = \frac{3}{4} [1 - \rho_{00} + (3\rho_{00} - 1)\cos^2\theta],$$

where  $\theta$  is the angle between the direction of the  $\rho^0$  in the rest frame of the final-state hadrons and the direction of the  $\pi^+$  in the rest frame of the  $\rho^0$ .<sup>19</sup>

For those pairs with  $z > 0.4$ ,  $\rho_{00}$  was determined by weighting each hadron pair by  $\cos^2\theta$ . The resulting mass distribution was analyzed as described above to determine the mean value of  $\cos^2\theta$  for the  $\rho^0$  signal. The value obtained for the  $\rho^0$  contribution was  $\rho_{00} = 0.41 \pm 0.08$ . This result is insensitive to track losses and radiative effects. The systematic error is estimated to be less than the statistical error. This result suggests that the zero-helicity state is more populated than the helicity  $\pm 1$  states.<sup>20</sup>

The ratio of the  $\rho^0$  production cross section to the average of the  $\pi^+$  and  $\pi^-$  production cross sections for  $z > 0.4$  was also determined. Owing to charge conjugation and isospin invariance, this ratio equals the ratio of the cross sections for  $\rho^0$  and  $\pi^0$  production. The charged-pion cross sections were measured in the same  $Q^2$  and  $W$  region as in the  $\rho^0$  analysis, except that for the  $\pi^+$  cross section the region  $W < 3.5$  GeV was eliminated to facilitate the subtraction of protons.<sup>21</sup> Elastic  $\rho^0$  events were not used in either the  $\rho^0$  or  $\pi^0$  cross-section determinations. The resulting  $\rho^0/\pi^0$  ratio is  $0.97 \pm 0.11$ . To approximate the ratio of  $\rho$  production to direct pion production, the pions with  $z > 0.4$  produced by  $\rho$  decay were subtracted from the pion cross section and the ratio  $R = \sigma^{\rho^0}/\sigma^{\pi^0}$  was found to be  $2.0 \pm 0.5$ . For this value we estimate an additional systematic uncertainty of  $\pm 0.3$ , mainly caused by the pion subtraction. According to the quark-parton model, the result for  $R$  should be directly comparable to measurements of  $R$  in  $pp$  collisions at high  $p_T$  or in  $e^+e^-$  annihilation. Our value of  $R$  is greater than that obtained at the CERN ISR in high- $p_T$  production ( $0.9 \pm 0.2$ ),<sup>22</sup> and less than the value reported in the  $e^+e^-$  annihila-

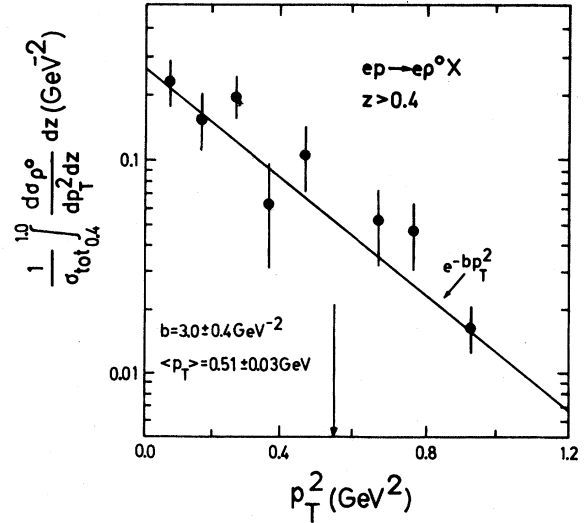

FIG. 7.  $p_T^2$  distribution for inelastically produced  $\rho^0$  mesons.

tion ( $3.1 \pm 0.6$ ).<sup>14</sup> It is also less than the value of 3 suggested by spin statistics. The product of  $R$  and  $\rho_{00}$  is the ratio of helicity-zero  $\rho^0$  production to  $\pi^0$  production. This is measured to be  $0.82 \pm 0.26$ , which is consistent with unity.

Using the vector-pseudoscalar ratio from this analysis and the SU(3) breaking from our  $K_S^0$  analysis,<sup>17</sup> and Field-Feynman model of quark fragmentation<sup>1</sup> predicts the ratio of  $K^{*\pm}$  to  $K^0$  plus  $\bar{K}^0$  production to be 1.5. This ratio was measured to be  $1.1 \pm 0.4$  by our observation of  $K^*(890)$  in the  $K_S^0 \pi^\pm$  channels.

## V. CONCLUSION

We have measured the electroproduction of  $\rho^0$  mesons up to  $W = 4.2$  GeV and  $Q^2 = 6$  GeV<sup>2</sup>. The elastic  $\rho^0$  production follows qualitatively the predictions of vector-dominance models. The inelastic production is well described by the fragmentation model of Field and Feynman<sup>1</sup> if the ratio of vector- to pseudoscalar-meson production is set to 2 in this model.

## ACKNOWLEDGMENTS

This work was supported in part by the Bundesministerium für Forschung und Technologie and the National Science Foundation. We gratefully acknowledge the support of Professor B. D. McDaniel, Professor H. Schopper, and the staffs of DESY and the Wilson Synchrotron Laboratory.

- \*Now at Tektronix, Inc., Beaverton, Oregon 97005.  
 †Now at SLAC, Stanford, California 94305.  
 ‡Now at Carnegie-Mellon University, Pittsburgh, Pennsylvania 15213.  
 §Now at Beiersdorf AG, Hamburg, Germany.  
 ||Now at Gesamthochschule Wuppertal, Wuppertal, Germany.
- <sup>1</sup>R. Field and R. Feynman, Nucl. Phys. **B136**, 1 (1978).  
<sup>2</sup>L. M. Sehgal, in *Proceedings of the 1977 International Symposium on Lepton and Photon Interactions at High Energies, Hamburg*, edited by F. Gutbrod (DESY, Hamburg, 1977).  
<sup>3</sup>B. Andersson *et al.*, Nucl. Phys. **B135**, 273 (1978).  
<sup>4</sup>L. Ahrens *et al.*, Phys. Rev. Lett. **42**, 208 (1979).  
<sup>5</sup>P. Joos *et al.*, Nucl. Phys. **B113**, 53 (1976).  
<sup>6</sup>C. del Papa *et al.*, Phys. Rev. D **19**, 1303 (1979).  
<sup>7</sup>Aachen-Berlin-Bonn-Hamburg-Heidelberg-München Collaboration, Phys. Rev. **175**, 1669 (1978); J. Ballam *et al.*, Phys. Rev. D **7**, 3150 (1973); J. T. Dakin *et al.*, *ibid* **8**, 687 (1973); W. R. Francis *et al.*, Phys. Rev. Lett. **38**, 633 (1977); J. Ballam *et al.*, Phys. Rev. D **10**, 765 (1974).  
<sup>8</sup>S. Stein, *et al.*, Phys. Rev. D **12**, 1884 (1974).  
<sup>9</sup>T. H. Bauer *et al.*, Rev. Mod. Phys. **50**, 261 (1978).  
<sup>10</sup>R. Feynman, *Photon-Hadron Interactions* (Benjamin, Reading, Massachusetts, 1972).  
<sup>11</sup>M. Holder *et al.*, Phys. Lett. **69B**, 377 (1977).  
<sup>12</sup>A. Benvenuti *et al.*, Phys. Rev. Lett. **41**, 1204 (1978).  
<sup>13</sup>C. del Papa *et al.*, Phys. Rev. Lett. **40**, 90 (1978).  
<sup>14</sup>J. Bürger, in *Gauge Theories and Leptons*, proceedings of the XIII Rencontre de Moriond, Les Arcs, France, 1978, edited by J. Trân Thanh Vân (Editions Frontières, Gif-sur-Yvette, 1979).  
<sup>15</sup>M. Derrick *et al.*, Phys. Lett. **91B**, 307 (1980).  
<sup>16</sup>I. Cohen *et al.*, Reports Nos. DESY 77/71 and CLNS-378, 1977 (unpublished).  
<sup>17</sup>I. Cohen *et al.*, Phys. Rev. Lett. **40**, 1614 (1978).  
<sup>18</sup>M. Deutschmann *et al.*, Nucl. Phys. **B103**, 426 (1976).  
<sup>19</sup>J. D. Jackson, in *High Energy Physics, 1965 Les Houchés Lectures*, edited by C. DeWitt and M. Jacob (Gordon and Breach, New York, 1966).  
<sup>20</sup>For discussion of the theoretical aspects, see, for example, J. F. Donoghue, Phys. Rev. D **19**, 2806 (1979); R. Suaya and J. S. Townsend, *ibid.* **19**, 1414 (1979); A. Seiden, Phys. Lett. **68B**, 157 (1977).  
<sup>21</sup>G. Drews *et al.*, Phys. Rev. Lett. **41**, 1433 (1978).  
<sup>22</sup>P. Darriulat *et al.*, Nucl. Phys. **B107**, 429 (1976).