

DEUTSCHES ELEKTRONEN-SYNCHROTRON **DESY**

DESY 83-073
September 1983

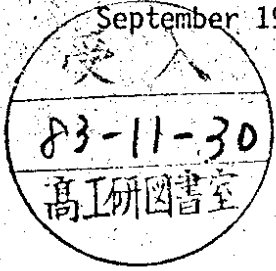

"SINGLE MODE CAVITIES"

A POSSIBILITY FOR FIGHTING COLLECTIVE BEAM INSTABILITIES

by

T. Weiland

Deutsches Elektronen-Synchrotron, DESY, Hamburg

ISSN 0418-9833

NOTKESTRASSE 85 · 2 HAMBURG 52

DESY behält sich alle Rechte für den Fall der Schutzrechtserteilung und für die wirtschaftliche Verwertung der in diesem Bericht enthaltenen Informationen vor.

DESY reserves all rights for commercial use of information included in this report, especially in case of apply for or grant of patents.

**To be sure that your preprints are promptly included in the
HIGH ENERGY PHYSICS INDEX ,
send them to the following address (if possible by air mail) :**

**DESY
Bibliothek
Notkestrasse 85
2 Hamburg 52
Germany**

"Single Mode Cavities"
A Possibility for Fighting Collective Beam Instabilities

Abstract

Copper accelerating cavities are usually optimized with respect to an optimum shunt impedance for the accelerating mode. Design criteria for superconducting cavities are different but in both cases the parasitic higher modes are often not taken into account as a priori design considerations. Transient wake fields and higher resonant modes also cause various serious types of instability and result in severe performance limitations for many existing and planned accelerators. Now that complete analysis of cavities has become possible by means of the programs TBCI and URWEL, cavities may be optimized for various requirements. As one result of such an optimization we present a cavity which has only one single axially symmetric mode: the accelerating one. At the same time the transient wake field effects in this cavity are significantly reduced.

"SINGLE MODE CAVITIES"

A POSSIBILITY FOR FIGHTING COLLECTIVE BEAM INSTABILITIES

T. Weiland

List of symbols

Q	quality factor
r/Q	geometric impedance per cavity cell
k_0	loss parameter of fundamental accelerating mode
k_{par}	parasitic loss parameter
$w_{ }^m$	longitudinal wake potential due to modes with azimuthal field varying as $\cos m\phi$ ($m = 0$ + monopole, $m = 1$ + dipole, ...)
w_{\perp}^m	transverse deflecting wake potential ($m > 0$ only)
ϕ	peak value of wake potentials
k_{\perp}^m	transverse kick parameter (ϕ averaged transverse force)
λ	bunch charge density
ΔQ_{\perp}	transverse tune shift (fundamental head tail mode)
I_b	single bunch current
$T_{rev.}$	revolution time
$\langle \beta \rangle_{rf}$	average beta function in the cavities
E_0	nominal particle energy

1. Introduction

The optimization of the shunt impedance of copper cavities is a common task for accelerator designers and many different shapes and types of cavities have been proposed in order to improve on this measure of merit.

For superconducting cavities the design criteria are different and the ratio of the peak field at the surface to the accelerating field becomes important too.

Cavity designers usually do not focus very much onto all the parasitic effects caused by the cavities as there are multi turn/multi bunch instabilities and single beam instabilities such as bunch widening, head tail turbulence and beam break up. The main reason for this is probably that serious considerations of such effects invoke quantitative knowledge of decelerating and deflecting modes and knowledge about transient fields.

Only recently has such quantitative investigation become possible: by means of the computer codes IBCI/1/2/ and URMEL /3/. Now that we are able to tell the computer the complicated shape of a cavity and to obtain a short time later a complete list of decelerating and deflecting modes plus transient decelerating and deflecting wake potentials we may think about an optimization taking all of these results a priori into account.

As a typical result of an optimization for a superconducting cavity at 1 GHz with a beam aperture of 9 cm we present here a single mode cavity (SMC), where essentially by opening up the beam holes we have created a cavity having only one single decelerating resonant mode. Two deflecting dipole modes are still present but there it is hoped that one of them (the "TM-like") can be removed by further optimization.

In parallel with the disappearing of the higher order modes the transient wake force effects are significantly reduced too. Thus qualitatively such a cavity aids removal of all longitudinal instabilities

due to resonant modes and quantitatively it helps to raise the threshold current for all "single passage" instabilities.

The modest price one has to pay is an increase in the peak surface field and a loss in shunt impedance. However the gain out weighs the disadvantage and the qualitative step of removing resonant modes totally may even be worth a higher price.

2. The Single Mode Cavity

2.1 Modes

As a starting point we use the superconducting 1 GHz cavity presently being built at DESY /4/ which will be run in nine cell units. The beam pipe aperture is 9 cm. The details of the shape are shown in figure 1.

The aims of the optimization was to remove as many resonant modes as possible in order to remove possible reasons for multi bunch (multi turn instabilities). The preliminary result that has been obtained is shown in figure 2. In the following we call the optimized form "B" and the previous one "A".

We first compare the mode structure of both types and find the significant difference in the fact that the two higher decelerating modes in type A no longer exist in type B. This has two major consequences: Nonexistent higher modes don't have to be damped by antennas in the cavities; nonexistent higher modes cannot lead to long range instabilities which are caused by a beam current that happens to drive a mode on resonance.

We also find at the same time that the shunt impedance decreased by 27 % and that the ratio E_{peak}/E_{accel} increased by 26 %. The increase in quality factor is not significant (less than 3 %).

Before we discuss the mode structure in the cavities we have to say something about the unusual nomenclature used here. In cavities with large beam holes the common identification of the modes as TM_{mnp} -modes is no longer meaningful. Therefore we use here a modified nomenclature as described in ref. 3. Modes are firstly identified by the azimuthal dependence of the field, i.e. the azimuthal mode number m . Only in the case of azimuthally symmetric fields we have to add TM or TE in front since two separate families exist. For all other modes the TM-TE identification breaks down since the modes have always both a magnetic and an electric longitudinal field component. Instead of radial and longitudinal mode numbers we use two letters according to the boundary conditions plus a running index. The letter "E" means

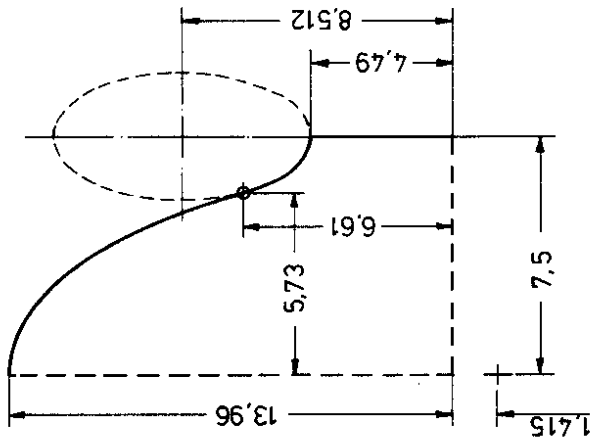

Figure 1
Cross section of a half cell of the superconducting PETRA cavity at 1 GHz

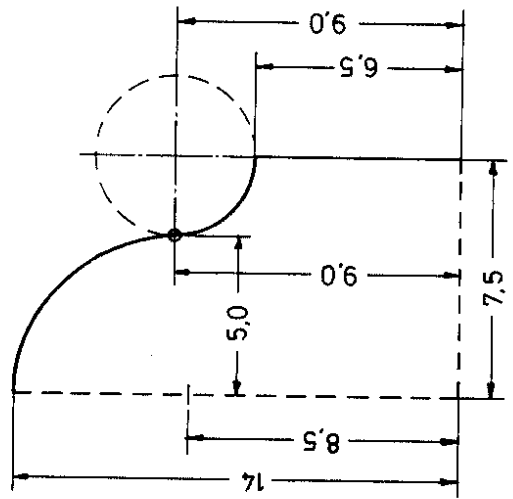

Figure 2
Cross section of a single mode cavity at 1 GHz

that the tangential electric field vanishes and "m" that the magnetic tangential field vanishes.

Two letters are used one for the mid plane and one for the beam pipe boundary. An additional running index is added for each such group of modes. The fundamental accelerating (TM₀₁₀- π^m -mode thus becomes the TM_{0-EM-1} mode, the "TM-like"-₁₁₀- π^m mode the 1-EE-1 mode and the "TM-like"-₁₁₀- π^m -mode the 1-FM-1 mode.

The coupling impedance r/Q scales as a^{2m} where a is the particle distance from the axis. Thus r/Q is given in ohms for the monopole modes and in ohms per square centimeter for dipole modes.

Table I compares all monopole and dipole modes found below cut off frequency. (We do not list here the TE_{0-np} modes since they do not couple to the beam). A complete mode investigation for type A may be found elsewhere /5/. Figures 3 and 4 show field plots of all these modes. The pass bands of the two dipole modes lie with one end above cut off frequency. Figure 5 shows the passband situation for both cavities with the two ends of each passband simply connected by a straight line. Multicell calculations have been performed but no anomalous dispersion could be observed, i.e. all modes found in a 9-cell cavities lay inside the pass band edge frequencies and the derivative did not change sign. For both cavities, in fig. 6, the accelerating mode - reasonably tuned to a flatness better than 90 % - Showing all the higher multicell modes would take too much space here.

We conclude so far that a qualitative change in the higher order mode structure has been obtained by opening the beam hole and that the decrease in shunt impedance is small.

Table I:

All modes of monopole and dipole type found below cutoff in both cavities.
 All r/Q are per cell and the transverse r/Q is per "transverse" centimeter squared.
 All calculations are done for one single cell cavity.

MONOPOLE		A		B		
Typ	f/MHz	r/Q/Ω	Q/10 ³	f/MHz	r/Q/Ω	Q/10 ³
TM0-EE-1 (TM020-0)	979	80	29	959	83	31
TM0-EM-1 (TM010-π)	994	55	29	1005	40	30
TM0-ME-1 (TM011-0)	1926	52	35	-	-	-
TM0-EE-2 (TM020-0)	1987	.1	42	-	-	-
TM0-MM-1 (TM011-π)	1998	17	34	-	-	-
TM0-EM-2 (TM020-π)	2054	7.6	44	-	-	-

DIPOLE		A		B		
Typ	f/MHz	r/Q/(Q/cm ²)	Q/10 ³	f/MHz	r/Q/(Q/cm ²)	Q/10 ³
1-MM-1 ("TE-110-π")	1275	0.72	30	1066	0.23	31
1-EM-1 ("TM-110-π")	1362	1.12	29	1261	0.71	29
1-EE-1 ("TM-110-0")	1421	1.16	36	-	-	-
1-ME-1 ("TE-110-0")	1434	0.24	52	-	-	-
(1-EM-2)("TE-120-π")	1902	0.47	41	-	-	-
1-EE-2 ("TE-120-0")	2396	0.22	74	-	-	-

2.2 Transient wake field effects

Although all higher longitudinal modes have been removed there is still a parasitic energy loss when a bunched beam passes through the cavity of type B. The difference is now that this energy does not sit in resonant fields but rather travels along the beam pipe where it can be damped away. Table II shows computed values for the total loss parameter for a bunch with $\sigma = 1$ cm (which is a typical number for PETRA). A more important quantity is probably the ratio of the parasitic loss and the fundamental loss parameter. With respect to parasitic energy loss this should be the figure of merit rather than the shunt impedance. As we see from Table II even the relative parasitic loss decreased significantly.

Figure 7 shows the decelerating wake potentials inside a gaussian bunch after the passage of three cells of cavity type A and B. It is found that the peak value of the decelerating wake force is reduced by 40 %.

Table II:

Comparison of the total energy loss for a single cell into parasitic fields k_{par} and the ratio to the fundamental loss parameter k_0 at rms bunch length of 1 cm.

	type A	type B
$k_{par}/(V/pC)$.353	.211
k_{par}/k_0	2.05	1.75

Transverse wake field effects are considered to be more severe than longitudinal ones. An interesting comparison is shown in figure 8 where the two transverse kick distributions are shown after the passage of three cavity cells of type A and B. It is found that the peak transverse kick is reduced by 58 %. Similarly to the parasitic loss, one can define an average transverse kick parameter

$$k_I = \left(\int_{-1}^1 (s)\lambda(s) ds \right) / \left(\int_{-1}^1 \lambda(s) ds \right)^2$$

This kick parameter k_{\perp}^1 is an integral measure for transverse forces and directly yields the well known tune shift ΔQ_{\perp} of the fundamental head tail mode as:

$$\Delta Q_{\perp} = \frac{\langle B \rangle}{4\pi E_0} \cdot k_{\perp}^1 \cdot I_b \cdot T_{rev}$$

Again we relate the parasitic transverse wake effect k_{\perp}^1 to the accelerating loss parameter and find that even then the gain is significant, see table II.

The longitudinal wake potential due to the dipole fields (W_{\parallel}^1) which is an important ingredient for synchro betatron resonances is also reduced enormously by more than 67 % as shown in figure 9.

Table III:
Comparison of the average transverse kick for a beam offset a (single cell)

	type A	type B
$k_{\perp}^1 / (\text{V/pC/m})$	3.2	1.0
$1 \text{cm} \cdot k_{\perp}^1 / k_0$	18.6	8.2

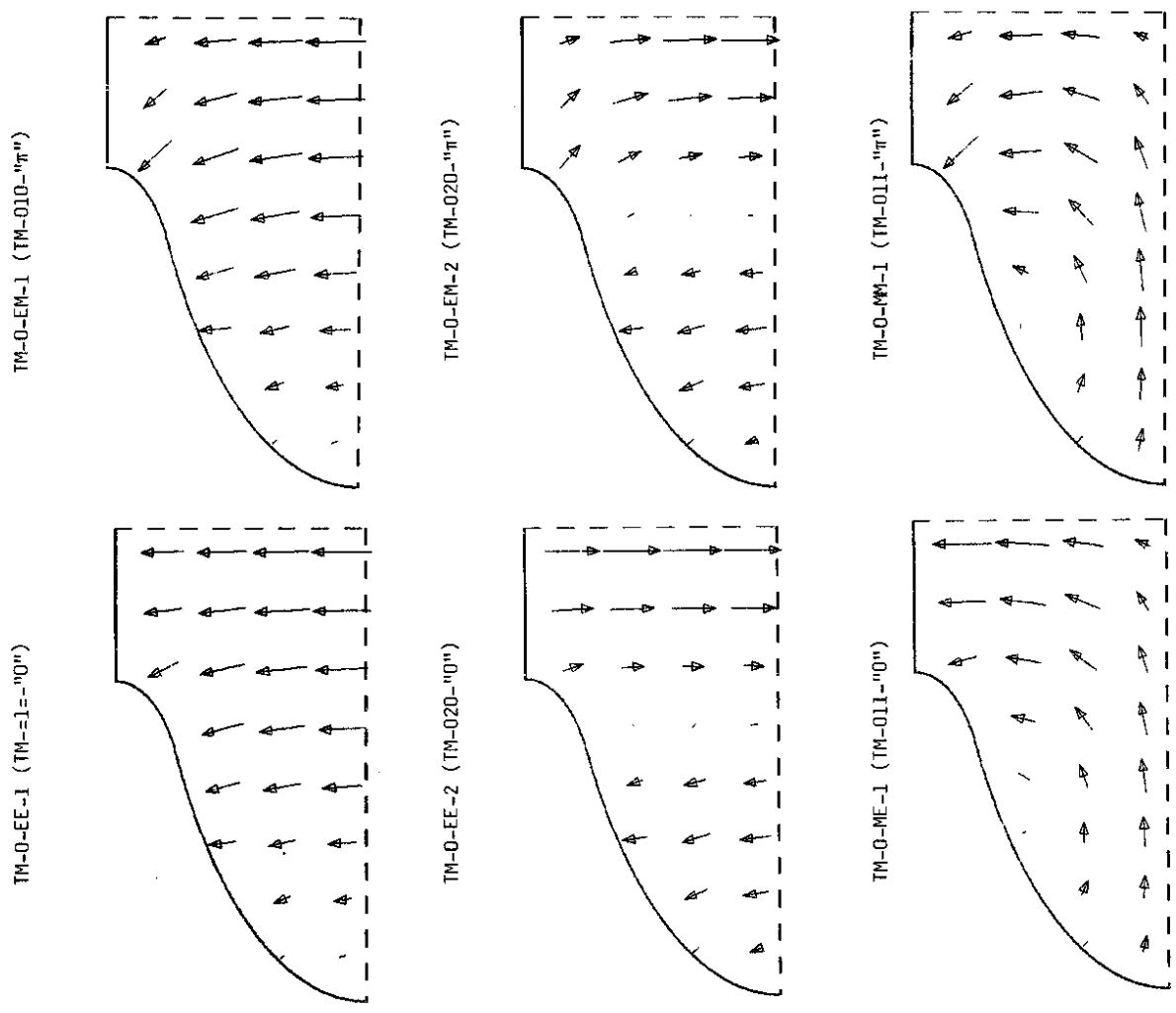

Figure 3 a All monopole TM-modes found in cavity A below cut off

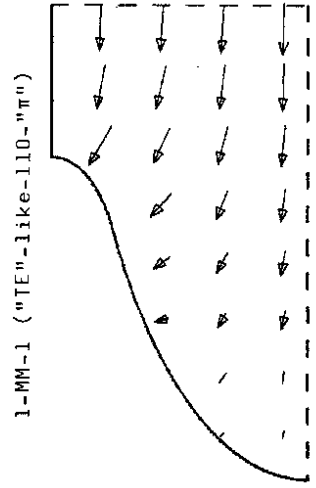
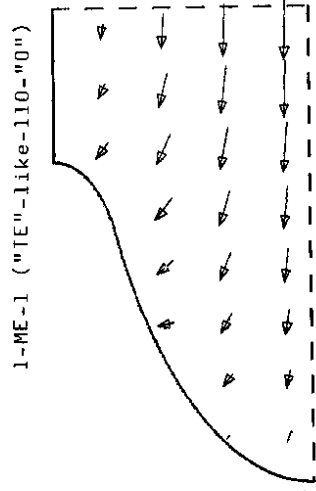
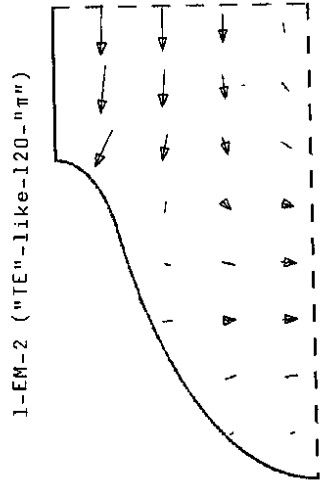
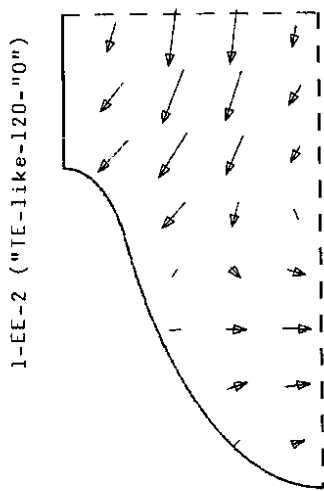
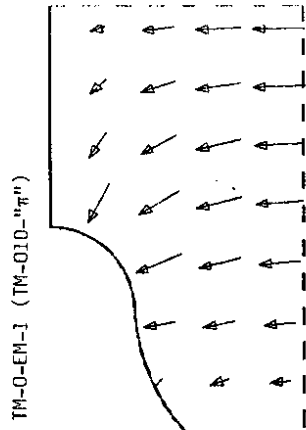
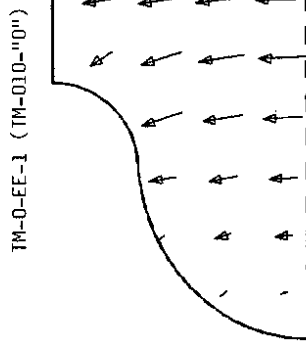
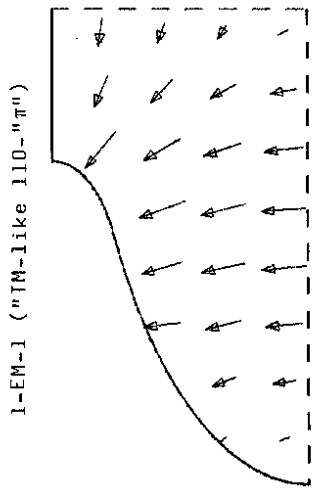
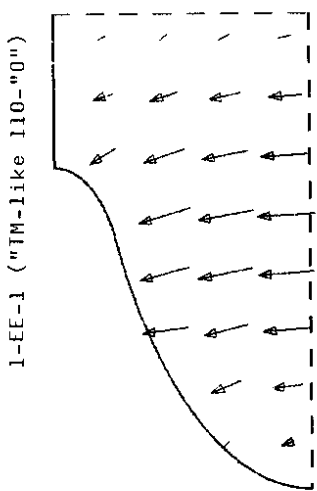

Figure 3b All dipole modes found in cavity A below cut off

Figure 4 a All monopole TM-modes found below cut off in the "Single Mode Cavity" (type B)

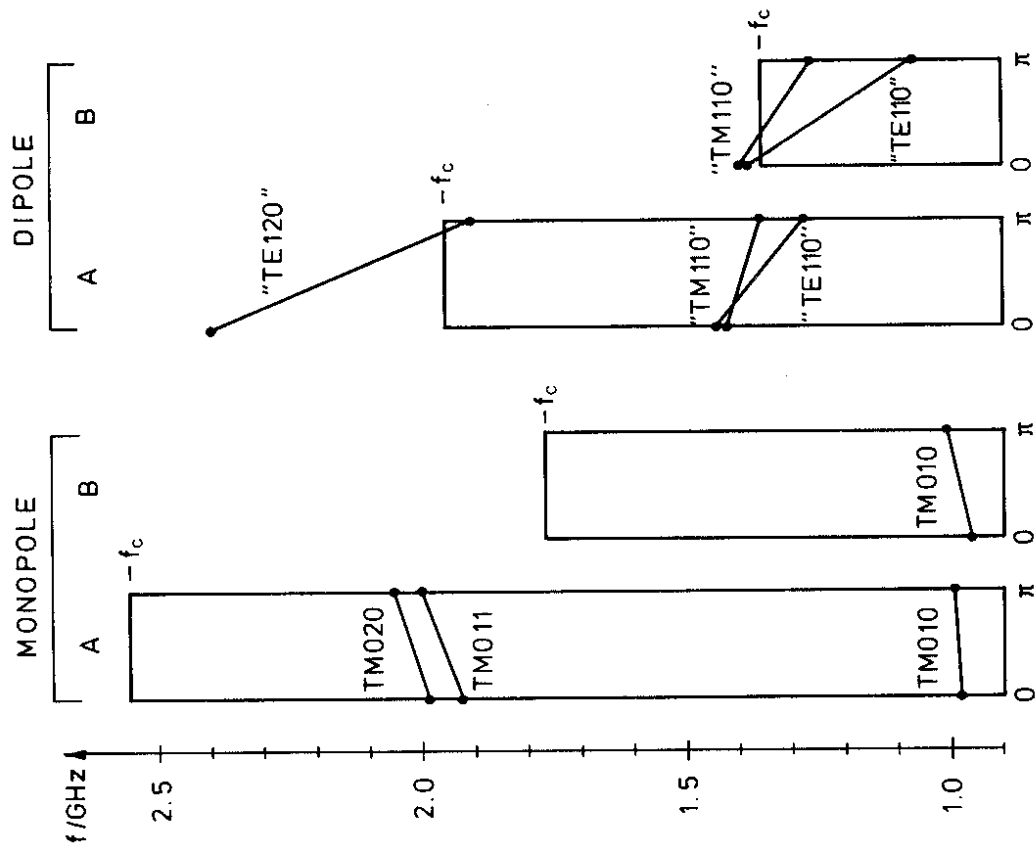

Figure 5 Passband ranges for both cavities. The upper end of each box represents the beam pipe cut off frequency f_c .

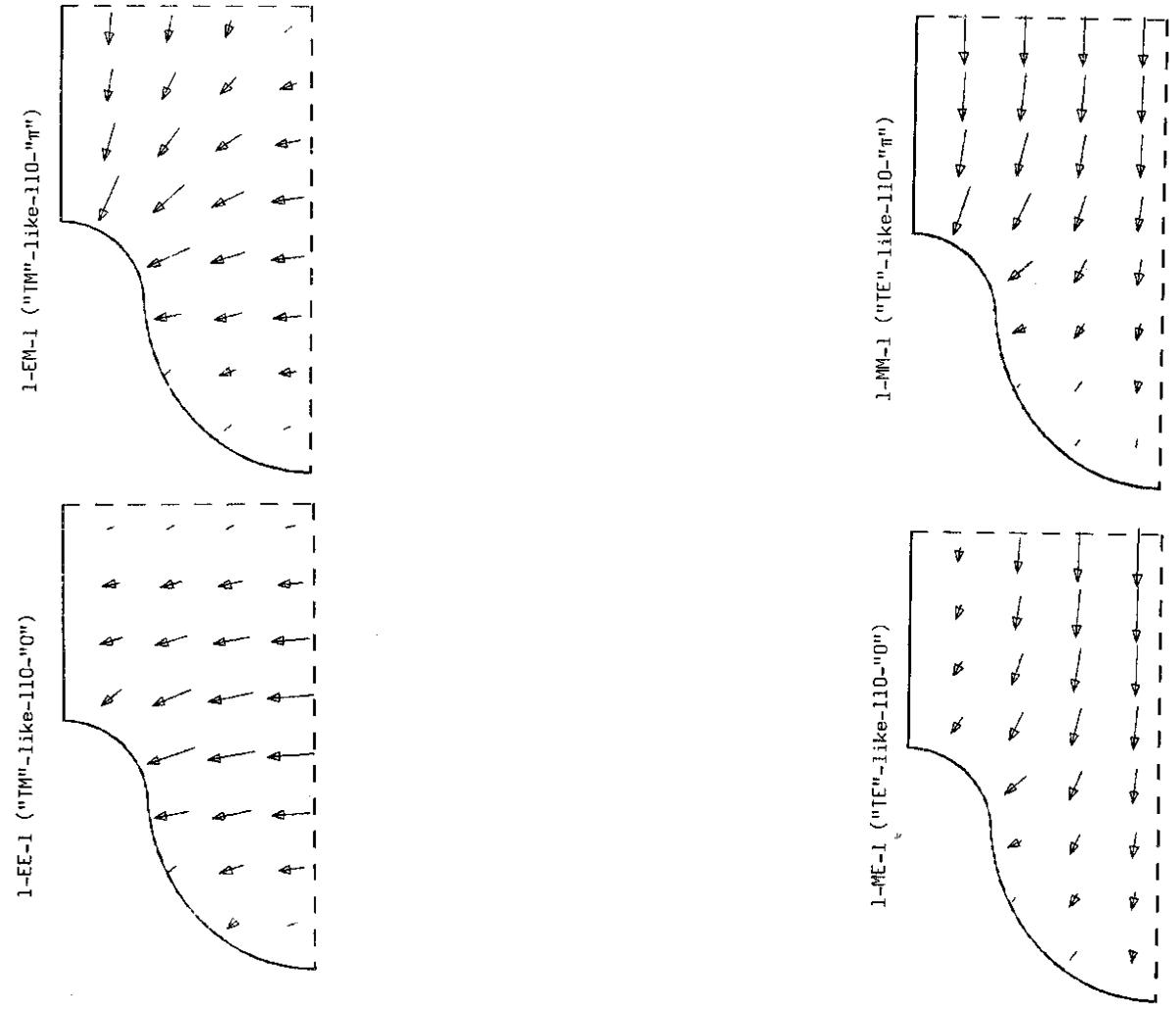

Figure 4 b All dipole modes found below cut off in the "Single Mode Cavity" (type B)

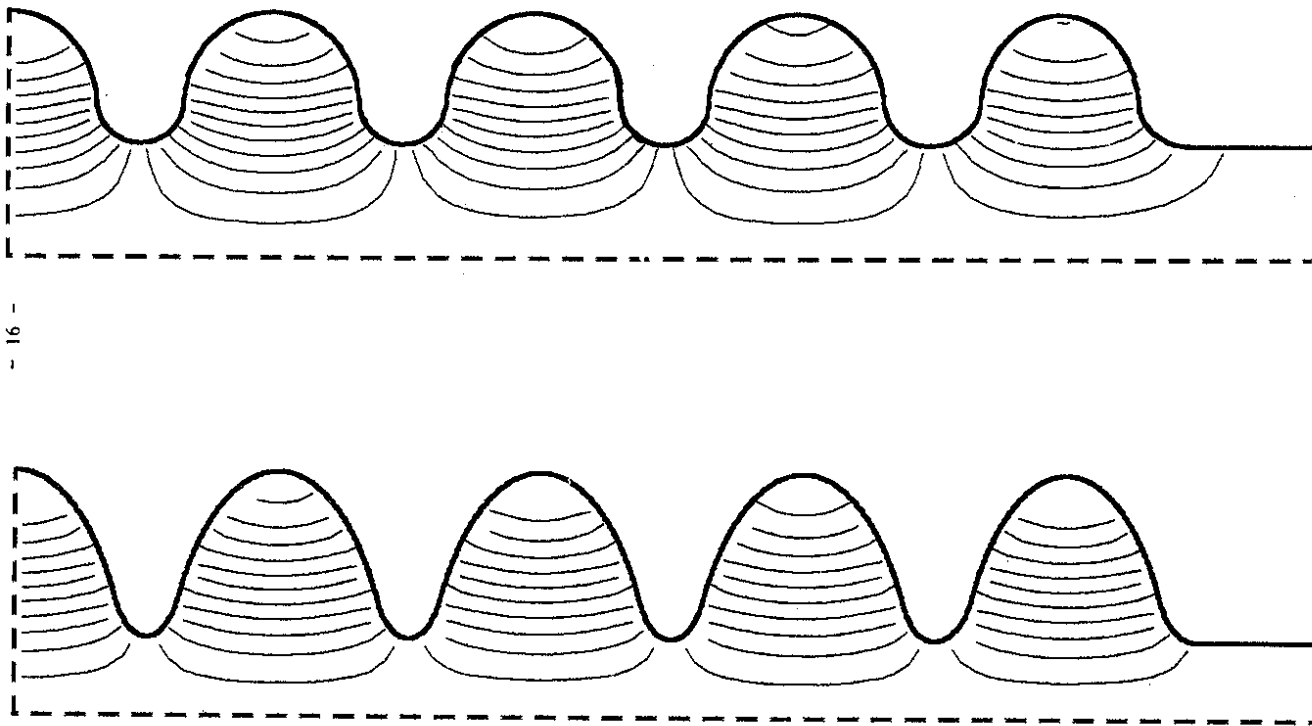

Figure 6 H -mode accelerating field structure (tuned to field flatness of 90 %)

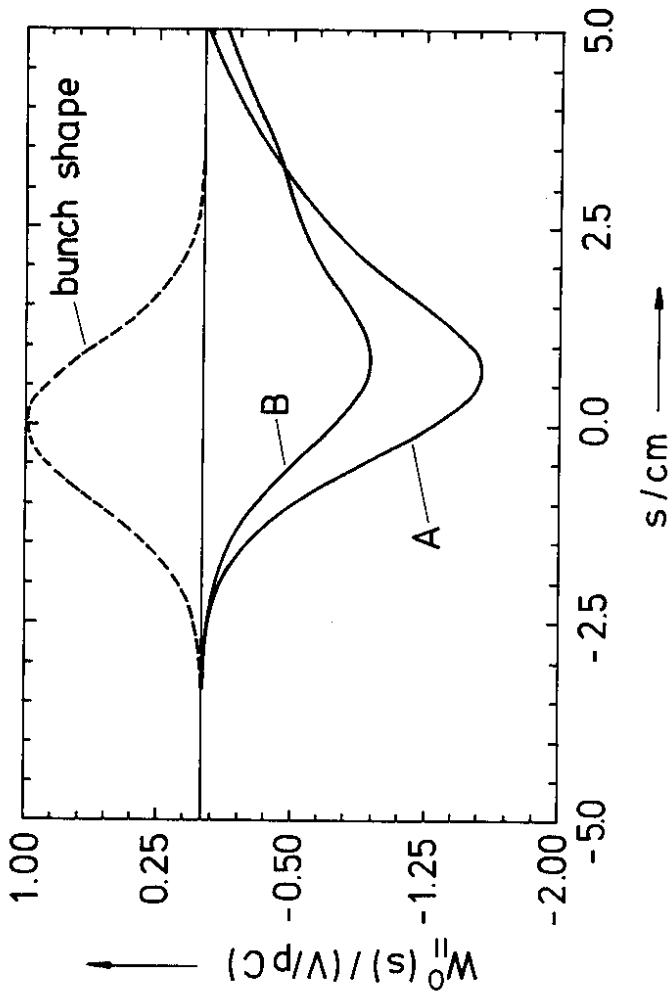

Figure 7 Decelerating wake potentials after three cavity cells for a bunch of the length $\sigma = 1$ cm on axis (monopole modes only)

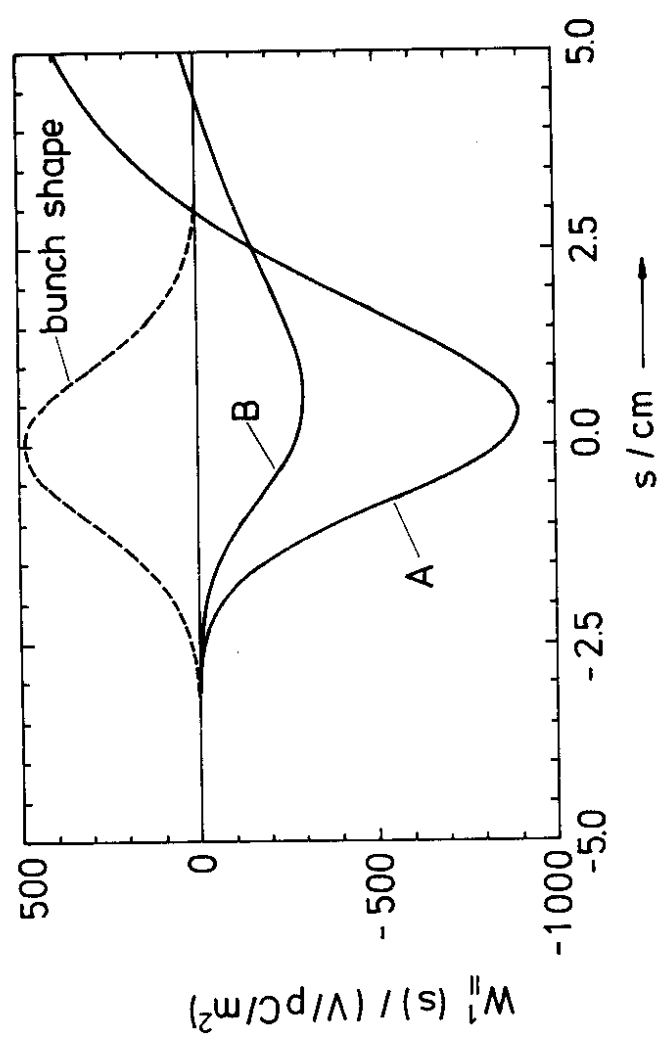

Figure 9 Longitudinal wake potential due to dipole fields inside a Gaussian bunch of the length $\sigma_z = 1$ cm after the passage of three cavity cells.

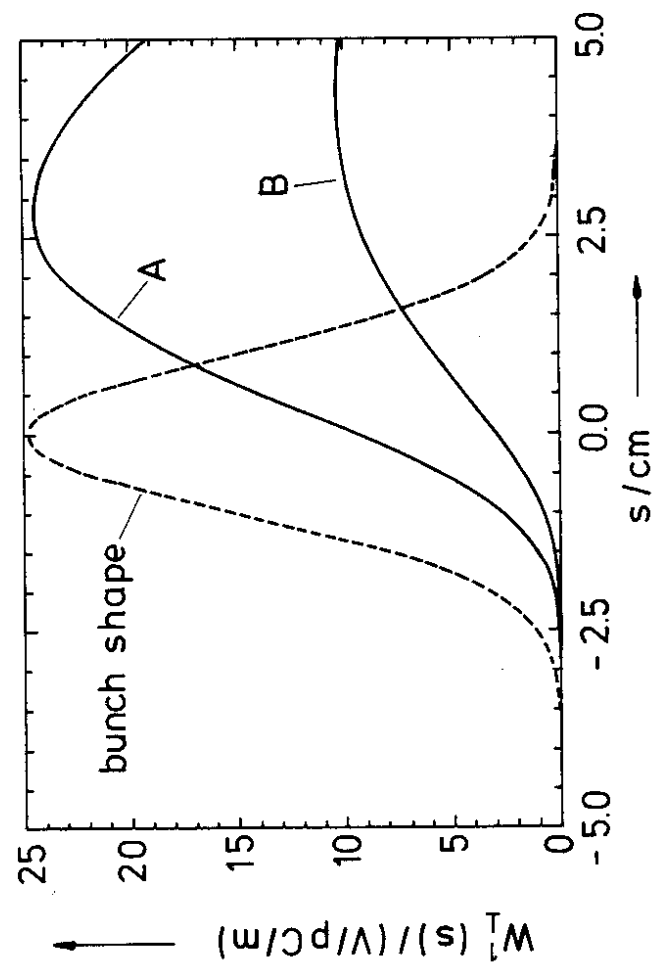

Figure 8 Deflecting dipole wake potentials inside a Gaussian bunch of the length $\sigma_z = 1$ cm due to three cavity cells

Table IV:
Summary of different results for both cavities

	cavity A	cavity B	(B-A)/A
$E_{\text{peak}}/E_{\text{acc.}}$	1.62	2.05	+ 26 %
$k_{\sigma} / (V/\text{pC})$	0.172	0.126	- 27 %
$r/Q / (\Omega/\text{cell})$	55.2	39.9	
$Q/10^3$	29	30	+ 3 %
$k_{\text{par}} (\sigma = 1 \text{ cm}) / (V/\text{pC}/\text{cell})$.353	.211	- 40 %
$k_{\text{par}}/k_{\sigma}$	2.04	1.75	- 14 %
$\hat{W}_{\text{II}}^0 / (V/\text{pC}/\text{cell})$	0.52	0.31	- 40 %
$k_{\text{I}}^1 (\sigma = 1 \text{ cm}) / (V/\text{pC}/\text{m}/\text{cell})$	3.2	1.0	- 69 %
$ak_{\text{I}} / k_{\sigma} (a=1\text{cm})$	18.6	8.2	- 58 %
$\hat{W}_{\text{I}}^1 / (V/\text{pC}/\text{m}/\text{cell})$	8.2	3.4	- 58 %
$\hat{W}_{\text{II}}^1 / (V/\text{pC}/\text{m}^2/\text{cell})$	296	100	- 67 %

3. Conclusion

By means of minor modifications to the superconducting PETRA cavity two parasitic decelerating modes can be shifted above cutoff frequency. As a result, the modified cavity has only one single monopole mode and that is the accelerating one (Single Mode Cavity). At the same time all the transient wake effects are also reduced by a significant amount. The loss in shunt impedance and the increase in surface field strength seems acceptable for all these improvements. Table IV summarizes results obtained and gives the relative changes from type A to B.

Further optimization will probably remove one deflecting dipole mode too (the "TM-like").

This type of "Single Mode Cavity" offers a promising possibility for fighting collective effects which seem to be the chief limiting effect for the performance of future electron accelerators.

4. Literature

- /1/ T. Weiland, XI International Conference on High Energy Accel. Geneva 1980, pp. 575
- /2/ T. Weiland, DESY 82-015, March 1982
- /3/ T. Weiland, DESY 83-005, February 1983
- /4/ Ebeling et al., Proceedings of the 1983 Accelerator Conference, Santa Fé, being published
- /5/ J. Peters, T. Weiland, DESY M 83-##, 1983, being published