

DEUTSCHES ELEKTRONEN-SYNCHROTRON **DESY**

DESY 85-115
WIS-85/40/OCT-PH
October 1985



B LIFETIME MEASUREMENTS FROM PETRA

by

H. Venkataramania

Physics Dept., University of Wisconsin, Madison

ISSN 0418-9833

NOTKESTRASSE 85 · 2 HAMBURG 52

DESY behält sich alle Rechte für den Fall der Schutzrechtserteilung und für die wirtschaftliche Verwertung der in diesem Bericht enthaltenen Informationen vor.

DESY reserves all rights for commercial use of information included in this report, especially in case of filing application for or grant of patents.

To be sure that your preprints are promptly included in the
HIGH ENERGY PHYSICS INDEX ,
send them to the following address (if possible by air mail) :

DESY
Bibliothek
Notkestrasse 85
2 Hamburg 52
Germany

B LIFETIME MEASUREMENTS FROM PETRA

Harsh Venkataramania *

Physics Department, University of Wisconsin, Madison **

INTRODUCTION

In the standard model the charged weak interaction mediated by W^\pm , mixes the lower members of the SU_2 doublets. The mixed quark states - d' , s' , b' - are related to the d , s and b states through the relation:

$$\begin{pmatrix} d' \\ s' \\ b' \end{pmatrix} = U_{K-M} \begin{pmatrix} d \\ s \\ b \end{pmatrix}$$

where U_{K-M} is a 3×3 unitary matrix known as the Kobayashi-Maskawa matrix -

$$U_{K-M} = \begin{pmatrix} U_{ud} & U_{us} & U_{ub} \\ U_{cd} & U_{cs} & U_{cb} \\ U_{td} & U_{ts} & U_{tb} \end{pmatrix}$$

The B lifetime, τ_B , is determined by the elements U_{ub} and U_{cb} which determine the rates of $b \rightarrow u$ and $b \rightarrow c$ transitions respectively. It is known from measurements at CESR that¹

$$\frac{|U_{ub}|}{|U_{cb}|} < 0.11 \text{ at } 90\% \text{ c.l.} \quad (1)$$

which implies that τ_B is essentially determined by $|U_{cb}|$. Conversely, from τ_B we can determine $|U_{cb}|$ and using Eq.(1) obtain an upper limit on $|U_{ub}|$. Knowledge of $|U_{cb}|$ and $|U_{ub}|$ and the other elements of the $K-M$ matrix enables theorists to make important predictions such as: the lower bound on the top quark mass², the lower bound on $\text{Re}(\epsilon'/\epsilon)$ ³, and size of mixing and CP violation in systems such as $B^0\bar{B}^0$ and $D^0\bar{D}^0$.⁴

THE JADE AND TASSO DETECTORS

Figure 1 shows the side view of the JADE detector. The jet chamber⁵ is used for reconstructing charged tracks, the lead glass shower counter for detecting electrons. Muons are detected by means of drift chambers interleaved between layers of iron/concrete absorbers.

Knowing the lifetime of bottom hadrons (B lifetime) it is possible to deduce the Kobayashi-Maskawa ($K-M$) matrix element $|U_{cb}|$ and together with the upper limit on $P_B = \frac{\Gamma(b \rightarrow u)}{\Gamma(b \rightarrow c)}$ from CESR obtain an upper limit on $|U_{ub}|$. Two detectors from PETRA, TASSO and JADE, have measured the B lifetime by first selecting a sample of b enriched events and then using the impact parameters of charged tracks in this sample. JADE does b enhancement using high P_t leptons while TASSO uses the higher sphericity of bottom jets compared to average jets. TASSO uses impact parameters of all "good" tracks in an event while JADE uses only that of the lepton. TASSO and JADE measure the B lifetime to be $1.57 \pm 0.32 + 0.37$ psec and $1.8 + 0.5 \pm 0.4$ psec respectively.

* Present address: Department of Physics, Yale University, New Haven, Connecticut 06511

Invited talk presented at the 20th Rencontre de Moriond: Electroweak Interactions, Les Arcs, France, March 17-23, 1985.

** Work supported by the US Department of Energy contract DE-AC02-76ER00881 and the US National Science Foundation grant number INT-8313994 for travel

The impact parameter resolution in the $r\phi$ plane - perpendicular to the beam direction - for charged tracks is 570 μm - including the contribution from the width of the beam. The first measurement layer of the jet chamber is located at a radius of 40 cm and the material in front of it amounts to 0.16 radiation lengths.

Figure 2 shows the end view of the central part of the TASSO detector; the parts important to the B lifetime analysis have been shaded.

The TASSO detector has existed in two different configurations - one before the installation of the vertex chamber (VXD)⁶: first configuration, and the other after the installation of VXD: second configuration.

For the first configuration the cylindrical drift chamber (CDC)⁷ plays the major role in the reconstruction of charged tracks while for the second configuration both CDC and VDX are used for this purpose. The parameters of the JADE and TASSO detectors relevant to the B lifetime analysis are listed in table I.

THE METHOD

So far all of the measurements of the B lifetime⁸⁻¹² except one¹³ have been done using a method consisting of the following two steps:

1. b enrichment: A sample of events is selected such that it is enriched in primary bottom hadrons.
2. Measurement of impact parameters: The impact parameters of tracks from the b enriched sample are used to find τ_B .

Table I. Parameters of JADE and TASSO: detectors relevant to the B lifetime analysis.

Detector +	JADE	TASSO I	TASSO II
Radius of first layer (cm)	40	36.7	8.1
Material before first layer (rad.len.)	0.16	0.13	0.007
Impact parameter resolution in the $r\phi$ plane including the beam size (μm)	570	1100 p>1 GeV/c	380
Impact parameter resolution in the $r\phi$ plane not including the beam size (μm)	450	1100 p>1 GeV/c	140

b enrichment

In e^+e^- annihilation into hadrons at a center of mass energy $W = 30-40$ GeV only $\sim 1/11$ of all events come from $b\bar{b}$ production. To increase the sensitivity to the B lifetime it is necessary to increase the fraction of $b\bar{b}$ events.

It is possible to select a sample of events enriched in the bottom flavor, because the bottom quark is much heavier than the up, down, strange and charm quarks. This implies that:

1. semileptonic decay of bottom hadrons can produce high P_t leptons. This is illustrated in Figure 3. The figure shows the P_t (transverse momentum with respect to the parton direction; the latter in practice can be approximated by the sphericity axis) spectrum of leptons, l , coming from the semileptonic decays - $c \rightarrow s\bar{l}\nu$, $b \rightarrow c\bar{l}\nu$, $b \rightarrow c\bar{l}\nu$, $b \rightarrow c\bar{l}\nu$.

We see that for $P_t > 1$ GeV/c most of the leptons come from the direct decay $b \rightarrow c\bar{l}\nu$.

2. b quark jets have a different shape from average jets. This comes from the fact that the total transverse momentum in an event gets contributions not only from hard gluon emission and fragmentation but also from the masses of the primary quarks. This causes b quark jets to have a higher sphericity compared to average jets.

Some of the event shape variables which have been used for flavor separation are listed below.

1. Σp_t - sum of transverse (relative to the jet axis) components of momenta of tracks in an event. For events originating from primary $b\bar{b}$ production Σp_t is large ^{8,14}.
2. Σp_t^{out} - same as Σp_t , except that the summation is carried over components transverse to the event plane. This variable is better than

Σp_t because it gets smaller contribution from hard gluon emission compared to Σp_t as hard gluon emission mainly contributes to transverse momentum in the event plane ^{8,14}.

3. Boosted sphericity product. This method was first proposed by TASSO ¹². The quantity is defined in the following manner: first, the hadronic event is divided into two by the plane perpendicular to the sphericity axis. Then for each hemisphere only those charged tracks which make an angle of less than 41° relative to the sphericity axis are considered; this is to reduce contribution from hard gluon radiation. The tracks in each hemisphere are then boosted towards the rest frame of the b quark with a boost $\beta \approx 0.7$. The sphericity of each hemisphere is then calculated. By requiring the product of the sphericities $S_1 S_2 > 0.1$, one obtains a sample consisting of about equal proportions of primary bottom, charm and light quark flavors and $\sim 40\%$ of the original bottom events are kept ¹².

4. Aplanarity - this is the smallest eigenvalue of the sphericity momentum tensor. It is on average bigger for $b\bar{b}$ events than for those originating from other primary quarks. JADE makes use of the property in one of their methods of measuring τ_B .

The impact parameter

The definition of the impact parameter of a track is illustrated in Figure 4. It is the distance of closest approach of the track to the interaction point of the event.

The average charged multiplicity in the decay of a bottom hadron is ¹⁵ $N_{CH} \approx 6$. If the bottom hadron has a nonzero lifetime then most of the tracks from the decay of a bottom hadron will have nonzero impact parameters. Thus by looking at the impact parameters of all tracks in a $b\bar{b}$ event one can derive a sensitive measure of the bottom hadron lifetime.

One can instead use the impact parameters of high p_t leptons produced in the semileptonic decay of a bottom hadron to measure τ_B . The advantages here are:

1. the semileptonic decays of bottom hadrons are understood¹⁶ better than the nonleptonic ones.
2. Production of high p_t leptons in e^+e^- annihilation at PEP and PETRA energies has been studied by a number of groups and the results are in good agreement.

Thus, using high p_t leptons it may be possible to measure τ_B with smaller systematic errors. All experiments which have determined the B lifetime so far have used the impact parameters of charged tracks in the $r\phi$ plane, i.e. the plane perpendicular to the beam axis, to make this measurement; we denote this variable by δ . The reason for this is that beamsize along the z direction is typically more than an order of magnitude bigger than the size in the $r\phi$ plane; in addition the detectors which have been used for measuring τ_B have much better measurement accuracies in the $r\phi$ plane compared to that along the z direction.

The resolution of δ of both JADE and TASSO is bigger than the average impact parameters expected for tracks from B decay if the B lifetime τ_B is 1 psec. As a result the measured δ of a track can be quite different from its true value. Therefore, it is important to associate a directional sign with the δ of a track. The way this is done is illustrated in Figure 5.

For an event with primary bottom quarks, the directions of motion of the primary bottom hadrons is well described by the sphericity axis. The directional sign of the δ is defined to be positive if the track crossed the sphericity axis in front of the interaction point and negative if it crossed behind the interaction point.

THE DATA

JADE's B lifetime measurement¹⁷ is based on 63 pb^{-1} of data collected at an average center of mass energy $\bar{W} \approx 35 \text{ GeV}$, corresponding to a total of 22000 hadronic events.

TASSO has used two sets of data:

1. 78.7 pb^{-1} of data collected with the first configuration of the detector (no vertex detector) at an average center of mass energy $\bar{W} = 34.6 \text{ GeV}$ and corresponds to a total of 22474 hadronic events.
2. 25 pb^{-1} of data collected with the second configuration of the detector (with vertex detector) at an average center of mass energy $\bar{W} = 44 \text{ GeV}$. This data set has 3964 hadronic events with useful vertex detector information; this is roughly twice the data with the second configuration compared to that used in the previous TASSO B lifetime publication.¹²

RESULTS

JADE has used two methods of determining the B lifetime. In their first method - which is their preferred method - they use only electron and muon candidates. The tracks are required to have momentum $p > 1.8 \text{ GeV}/c$ and transverse momentum relative to the jet axis $p_t > 0.9 \text{ GeV}/c$. To ensure good track reconstruction the polar angle of the track θ is required to satisfy $45^\circ < \theta < 135^\circ$ and the azimuthal angle ϕ between the track and the sphericity axis $6^\circ < \phi < 57^\circ$. After applying further cuts: lepton be isolated, the event should have a limited width in the event plane - they are left with 74 muon and 34 electron candidates. By visually scanning they eliminate 9 electron candidates as coming from photon conversion. The compositions of the resulting electron and muon samples are indicated in table 2.

	μ	e
B \rightarrow lepton %	65	79
B \rightarrow C \rightarrow lepton %	6	8
C \rightarrow lepton %	8	10
Hadrons %	20	3
K, π \rightarrow lepton %	1	

Table 2. Composition of the lepton sample used by JADE to measure the B lifetime, estimated using a Monte Carlo technique.

Figure 6 shows the δ distributions of the selected muon and electron tracks. In both cases the distribution is not in agreement with a Gaussian centered at 0 and having a $\sigma = 570 \mu\text{m}$ which is JADE's δ resolution. If they allow the mean to vary in the fit then they obtain $\langle\delta\rangle = 282 \pm 78 \mu\text{m}$ and $457 \pm 107 \mu\text{m}$ for the muon and electron samples respectively.

They infer the B lifetime, τ_B , by doing a maximum likelihood fit which uses as input the fractions and the δ distributions of the various components which are: B \rightarrow lepton, B \rightarrow C \rightarrow lepton, C \rightarrow lepton and background. The δ distributions for the different components are obtained from Monte Carlo calculations and depend on the δ resolution of the detector and in the case of B \rightarrow lepton and B \rightarrow C \rightarrow lepton also on τ_B .

From the maximum likelihood fit they deduce

$$\tau_B = 1.78 \pm 0.55 \text{ psec}$$

and

$$\tau_B = 1.73 \pm 0.90 \text{ psec}$$

for the muon and electron samples respectively; combining they obtain

$$\tau_B = 1.76 \pm 0.45 \text{ psec}$$

JADE has used tracks from their hadronic events sample to construct a control sample δ distribution. They apply the same event and track requirements for this sample as they do for the muon candidates except:

1. The tracks are not electron or muon candidates
2. The tracks have $p > 2.0 \text{ GeV}/c$
3. the only b-enrichment cut applied is that the tracks be isolated.

Gaussian fit to the selected tracks yields $\langle\delta\rangle = 42 \pm 21 \mu\text{m}$. If they subtract the contribution from B and C decays estimated from the Monte Carlo they obtain $\langle\delta\rangle = -6 \pm 24 \mu\text{m}$.

In contrast to JADE, TASSO uses all charged tracks to determine the B lifetime - no lepton identification is required. The following cuts are applied:

1. $|\cos\theta_{\text{jet}}| < 0.7$ where θ_{jet} is the polar angle of the sphericity axis - this is to ensure proper determination of the B direction of flight.
2. Beamspot for the event is required to be known.
3. The tracks are required to satisfy

$$a. |z_0| < 2 \text{ (3) cm at } \bar{W} = 34.6 \text{ (44) GeV where } z_0 \text{ is the z coordinate at the point of closest approach to the beamspot.}$$

$$b. \text{ The track fit Chi-squared } \chi^2_{\text{fit}} < 2 \text{ (5) at } \bar{W} = 34.6 \text{ (44) GeV,}$$

$$\chi^2_z < 2,$$

4. for the $\bar{W} = 44$ GeV data, each track is required to have at least 5 hits in the vertex chamber.
5. To reduce multiple scattering, tracks are required to have momentum $p > 1$ GeV/c.
6. The boosted sphericity product method described earlier is used for selecting a b enriched and a b depleted sample. The b enriched sample is obtained by using boost $\beta = 0.70$ (0.74) at $\bar{W} = 34.6$ (44) GeV and $S_{12} > 0.1$. The b depleted sample is selected using the same value of β but with $S_{12} < 0.04$.

The resulting b enriched sample consists of 7526 (1530) tracks at $\bar{W} = 34.6$ (44) GeV.

Figure 7 shows the δ distribution for both the b enriched and the b depleted data samples for the second configuration of the TASSO detector. From the figure we can see that the distribution for the b enriched data sample is significantly shifted to the right. The mean value of δ for $|\delta| < 0.5$ cm is 91 ± 17 μ m (38 ± 8 μ m) for the b enriched (b depleted) data sample.

Figure 8 shows the δ distribution for the b enriched and b depleted data samples for the first configuration of the TASSO detector. Again the δ distribution for the b enriched sample is shifted to the right. The mean value of δ for $|\delta| < 0.5$ cm is 105 ± 17 μ m (58 ± 8 μ m) for the b enriched (b depleted) data sample.

The figure also shows the asymmetry distribution obtained by subtracting the left side of the δ distribution from the right side. We see that the data are not compatible with the Monte Carlo expectation for $\tau_B = 0$ while $\tau_B = 2$ psec describes the data fairly well.

TASSO deduces the B lifetime τ_B comparing the value of $\langle \delta \rangle$ for the data with the Monte Carlo expectation for different values of τ_B ; this is shown in Figure 9. From the figure we obtain for the B lifetime 1.85 ± 0.49 (1.36 ± 0.42) psec for the first (second) configuration. The value for the second configuration differs from the published value of 1.80 ± 0.58 - 0.57 psec due to the increase in statistics.

CHECKS

JADE has measured the τ lifetime using impact parameters of charged tracks from events of the type $e^+ e^- \rightarrow \tau^+ \tau^-$. The τ lifetime they measure is in agreement with the value measured by MARK II¹⁸.

They have used another method to measure the B lifetime. They have used all events with muon candidates. Each track in the event is given a weight dependent on the P_t of the muon and the aplanarity of the event. From the δ distribution they deduce $\tau_B = 1.7 \pm 0.6$ psec.

TASSO has measured the average charm lifetime τ_C by using tracks from the b depleted data samples. They measure it to be $\tau_C = (1.3 \pm 0.3)\tau_C^{nom}$ where τ_C^{nom} is the average charm lifetime estimated from the lifetimes of D^0, D^+, F, Λ_c and their relative proportions in hadronic events.

TASSO has also looked at the impact parameter distribution of charged tracks in events of the type $e^+ e^- \rightarrow \tau^+ \tau^-$. The value of $\langle \delta \rangle$ is in good agreement with the value expected from Monte Carlo using the known τ lifetime.

In addition they find that $\Upsilon\Upsilon$ events have $\langle \delta \rangle$ consistent with zero.

They have investigated instrumental biases by dividing tracks depending on charge, the sign of p_x (x component of momentum), the sign of p_y (y component of momentum), sign of p_z (z component of momentum) and comparing $\langle \delta \rangle$. They find the differences to be statistically not significant.

SYSTEMATIC ERROR

The dominant source of systematic error for the JADE measurement of the B lifetime is the uncertainty in the fraction of B → lepton decays which contribute an error of ±0.30 psec. The other sources of systematic error are the choice of the jet axis (±0.05 psec) uncertainty in the δ resolution (±0.15 psec) uncertainty in the relation between δ and τ_B (±0.15 psec) and the uncertainty in the average charm lifetime (±0.05 psec).

In the case of TASSO, the dominant sources of systematic error are the uncertainties in the fragmentation parameters (±0.27 psec), uncertainties in the decays of charm and bottom hadrons (±0.21 psec). Possible instrumental biases and dependence of τ_B on the cuts employed in the analysis contribute ±0.16 and ±0.14 psec respectively to the systematic error. Combining the errors in quadrature we obtain an overall systematic error of ±0.40 psec.

JADE quotes the result obtained using their first method as their final value of the B lifetime which is τ_B = 1.8 ± 0.5 (stat.) ± 0.4 (sys.) psec.

TASSO's final result is obtained by statistically combining the results from the two configurations of the detector which gives

$$\tau_B = 1.57 \pm 0.32 \text{ (stat.)} + 0.37 \text{ (sys.) psec.}$$

K-M MATRIX

|U_{cb}| is deduced from the formula¹⁹

$$|U_{cb}| = \left[\frac{\text{BR}(B \rightarrow X_{cb})}{\tau_B} \cdot \frac{K_{cb}}{1 + R_B} \right]^{1/2}$$

where BR(B → X_{cb}) is the semileptonic branching ratio for B mesons,

$$K_{cb} = (2.35 \pm 0.13) \times 10^{-14} \text{ sec and}$$

$$R_B = \frac{\Gamma(B \rightarrow X_U \ell \bar{\nu})}{\Gamma(B \rightarrow X_C \ell \bar{\nu})}$$

which from measurements at CESR is known to be less than 0.038 at 95% c.l. From the above expression we obtain

$$|U_{cb}| = 0.042 \pm 0.005 \text{ (stat.)} \pm 0.006 \text{ (sys.)}$$

$$|U_{cb}| = 0.039 \pm 0.005 \text{ (stat.)} \pm 0.005 \text{ (sys.)}$$

In addition an error of ± 0.002 should be considered for either values due to uncertainties in BR(B → X_{cb}), K_{cb} and R_B.

COMPARISON WITH OTHER EXPERIMENTS

Figure 10 shows the values of τ_B as measured by different groups at PEP²⁰ and PETRA. The errors on the points are obtained by combining the statistical and systematic errors in quadrature. The weighted average of all measurements is τ_B = 1.10 ± 0.16 psec with χ² of the least square fit to a constant is 4.8 for 6 degrees of freedom; however the weighted average of PEP measurements is 0.94 ± 0.18 psec while that of PETRA is 1.67 ± 0.33 psec.

CONCLUSIONS

Both JADE and TASSO have measured the B lifetime. JADE has used two different methods while TASSO used data taken with two different detector configurations and at different center of mass energies. Their values of τ_B are 1.8 ± 0.5 ± 0.4 psec (JADE), 1.57 ± 0.32 ± 0.37 psec (TASSO) are in good agreement with each other. The weighted average of all measurements from PEP and PETRA is 1.10 ± 0.16 psec and the χ² of the least square fit to a constant is 4.8 for 6 degrees of freedom. The combined average of PEP measurements is 0.94 ± 0.18 psec while the weighted average from PETRA is somewhat higher - 1.67 ± 0.33 psec.

ACKNOWLEDGEMENTS

For this very enjoyable and stimulating conference I thank the organizers, especially J. Tran Thanh Van and J. Grivaz. I thank the DESY Directorate for their continuing support of the experiments at PETRA and the PETRA machine group for their tremendous efforts. I am grateful to all members of the TASSO Collaboration for numerous discussions. In particular, I would like to thank Professor Sau Ian Wu for her constant encouragement. I would like to thank the DESY Directorate for the hospitality extended to me while working at DESY. I thank Greg Baranko and Jean Slaughter for critical reading of the manuscript, and Martha Bennett and Pat Hatcher for the careful typing of it. This work was supported by U.S. Department of Energy contract DE-AC02-76ER00881 and the US National Science Foundation grant number INT-8313994 for travel.

REFERENCES

1. J.Lee-Franzini, invited talk at the Europhysics Study Conference in Flavor Mixing in Weak Interactions, Erice, March 1984
2. P.H.Ginsparg, S.L.Glashow and M.B.Wise, Phys. Rev. Lett. 50 (1983) 1415.
3. F.J.Gilman and J.S.Hagelin, Phys. Lett. 126B (1983) 111; P.Ginsparg and M.B.Wise, Phys. Lett. 127B (1983) 265.
4. E.A.Paschos, B.Stech and U.Tuerke, Phys. Lett. 128B (1983) 240.
5. J.H.Heintze, Nucl. Instr. Meth. 156 (1978) 227.
6. D.M. Binnie et al., DESY 84-060 (1984).
7. H.Boerner et al., Nucl. Instr. Meth. 176 (1980) 151.
8. JADE Collab., W.Bartel et al., Phys. Lett. 114B (1982) 71.
9. MAC Collab., E.Fernandez et al., Phys. Rev. Lett. 51 (1983) 1022.
10. MARK II Collab., N.S.Lockyer et al., Phys. Rev. Lett. 51 (1983) 1316.
11. DELCO Collab., D.E.Klem et al., Phys. Rev. Lett. 53 (1984) 1873.
12. TASSO Collab., M.Aithoff et al., Phys. Lett. 149B (1984) 524.
13. K.Hayes, Proceedings of the DESY theory workshop, Hamburg, 1984.
14. R.Marshall, RAL-84-002.
15. CLEO Collab., M.S.Alam et al., Phys. Rev. Lett. 49 (1982) 357.
16. G.Altarelli et al., Nucl. Phys. B208 (1982) 365.

- 17. P. Steffen, 22nd International Conference on High Energy Physics, Leipzig, 1984, and private communication from J. Spitzer.
See also G. Wolf, SLAC-PUB-3446.
- 18. MARK II Collab., J.A. Jaros et al., Phys. Rev. Lett. 51 (1983) 955.
- 19. J. Lee-Franzini, Proceedings of the Moriond Conference, 1984, p. 477.
- 20. R. Prepost, these proceedings.

FIGURE CAPTIONS

- Fig. 1. The side view of the JADE detector: JADE's B lifetime analysis mainly uses the jet chamber (5), the central lead glass counters (8) and the muon chambers (4).
- Fig. 2. The central part of the TASSO detector: The figure shows the end view of the TASSO detector. The parts which play an important role in the B lifetime analysis, the drift chamber and the vertex chamber, have been shaded.
- Fig. 3. Transverse momentum spectrum of e, μ from B, C decays: The figure shows that B decays can lead to the production of high p_t leptons. Thus, high p_t leptons ($p_t \geq 1 \text{ GeV}/c$) can be used to tag events with primary bottom hadrons.
- Fig. 4. The definition of the impact parameter: The impact parameter, d , is nonzero for tracks coming from decays of particles with finite decay distances. In practice, the impact parameter in the $r\phi$ plane, δ , instead of the impact parameter in space, d , is used.
- Fig. 5. The sign of the impact parameter: The sign of the impact parameter is obtained by looking at where the track intersects the sphericity axis - s. If a track belonging to the jet moving to the right intersects the axis to the right (left) of the beamspot the sign is positive (negative).
- Fig. 6. δ distributions of e, μ tracks from the b enriched sample (JADE): In the figures shown the histograms correspond to the data, the dashed lines are Gaussians centered at zero and having $\sigma = 570 \mu\text{m}$ determined by the resolution of the detector, the solid curves are Gaussians obtained by fits to the data allowing the mean to vary.

MAGNETDETEKTOR
MAGNET DETECTOR JADE

- 1 Strahlrohrzähler
- 2 Endseitige Bleiglaszähler
- 3 Drucktank
- 4 Myon-Kammern
- 5 Jet-Kammern
- 6 Flugzeitzähler
- 7 Spule
- 8 Zentrale Bleiglaszähler
- 9 Magnetjoch
- 10 Myon-Filter
- 11 Beweglicher Endstopfen
- 12 Strahlrohr
- 13 Vorwärts-Detektor
- 14 Mini-Beta Quadropol
- 15 Fahrwerk

- 1 beampipe counters
- 2 end plug lead glass counters
- 3 pressure tank
- 4 muon chambers
- 5 jet chambers
- 6 time of flight counters
- 7 coil
- 8 central lead glass counters
- 9 magnet yoke
- 10 muon filters
- 11 removable end plug
- 12 beam pipe
- 13 tagging counter
- 14 mini beta quadropole
- 15 moving devices

Gesamtgewicht: ~1200t
TOTAL WEIGHT

Magnetfeld: 0,5T
MAGNETIC FIELD

Beteiligte Institute:
PARTICIPANTS

DESY, Hamburg, Heidelberg,
Lancaster, Manchester,
Rutherford Lab., Tokio

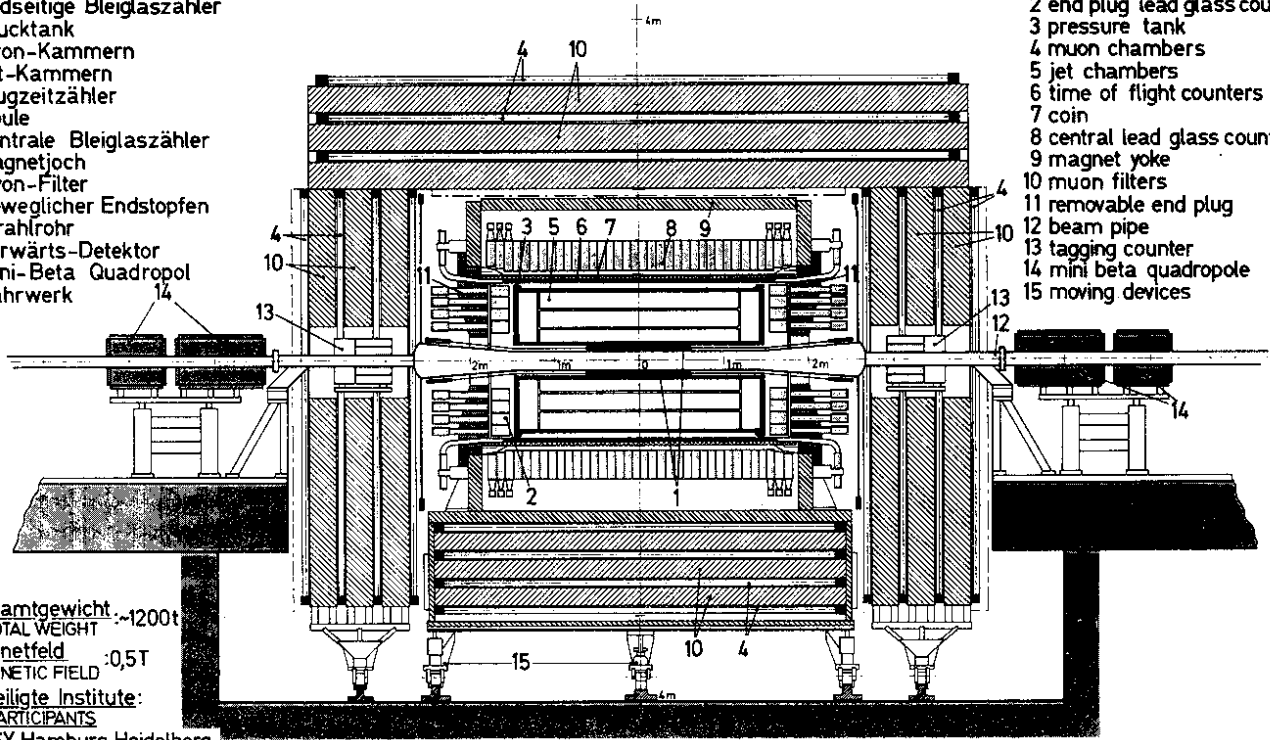

Figure 1

35152

Fig. 7. The δ distribution of tracks for the second configuration (TASSO): The figure shows the δ distribution of tracks for the b enriched (solid + shaded) and the b depleted (dashed + unshaded) samples. Both histograms have been normalized to unity. The b enriched distribution shows a larger asymmetry.

Fig. 8. The δ distribution of tracks for the first configuration (TASSO): The figure (top) shows the δ distributions of tracks for the b enriched (solid + shaded) and the b depleted (dashed + unshaded) samples. The distributions obtained by taking the difference of the left side of histogram from the right (the two bottom figures) are in agreement with the Monte Carlo prediction for $\tau_B = 2$ psec and are not in agreement with that for $\tau_B = 0$.

Fig. 9. B lifetime versus $\langle\delta\rangle$ (TASSO): The figure shows the τ_B versus $\langle\delta\rangle$ relation obtained using Monte Carlo events generated with different τ_B . In the figure the shaded regions correspond to the two measurements. The value of τ_B obtained with the second configuration of TASSO has changed since the last publication; the previous value is also shown.

Fig. 10. B lifetime measurements from PEP and PETRA: The figure shows the values of τ_B as measured by different experiments at PEP and PETRA. The measurements have been divided into two categories: one which uses the lepton impact parameter and the other which in addition also uses tracks which have not been identified as leptons. The weighted average is $\tau_B = 1.10 \pm 0.16$ psec and the χ^2 of the least square fit to a constant is 4.8 for 6 degrees of freedom.

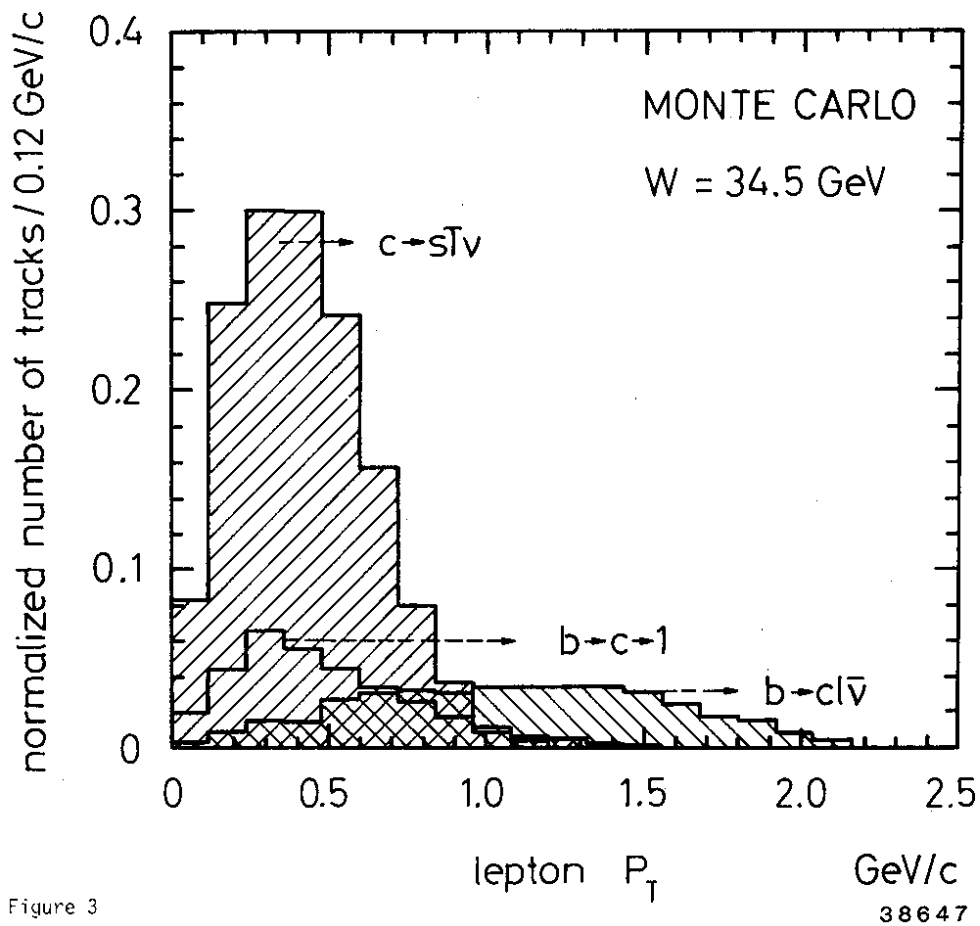
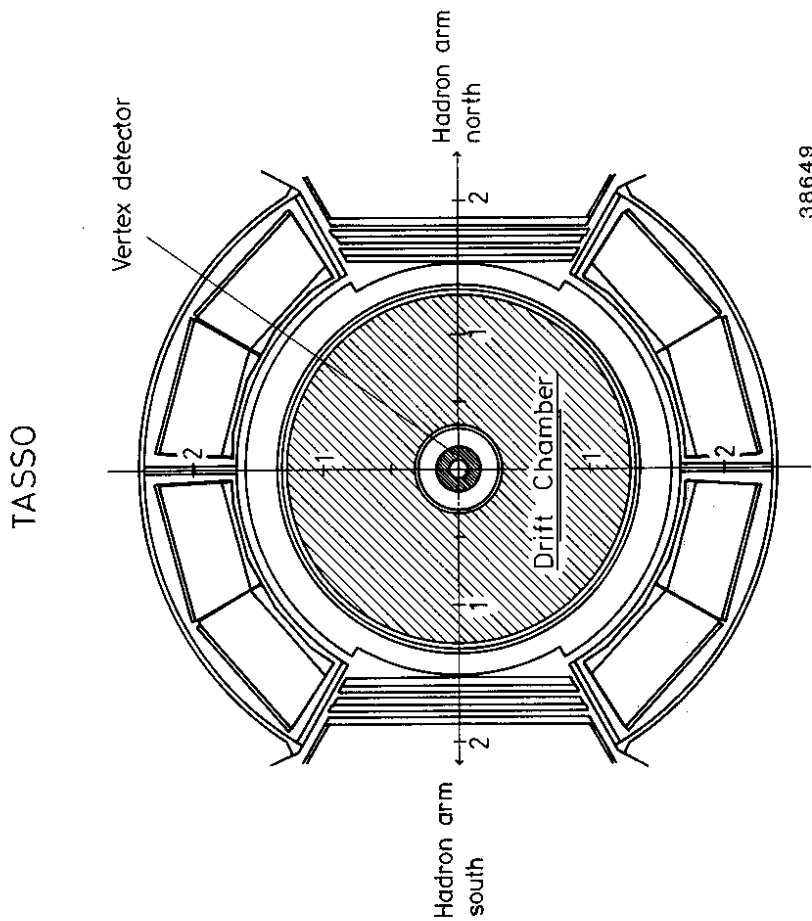
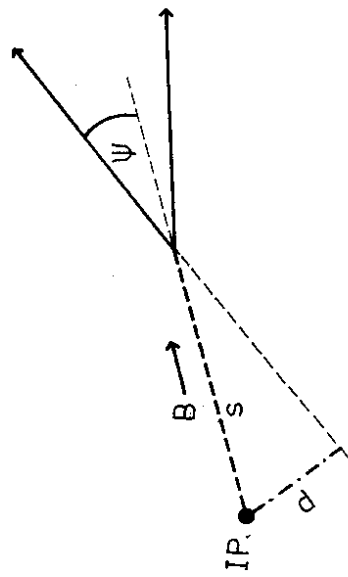

Figure 3

38647





37631

Figure 4

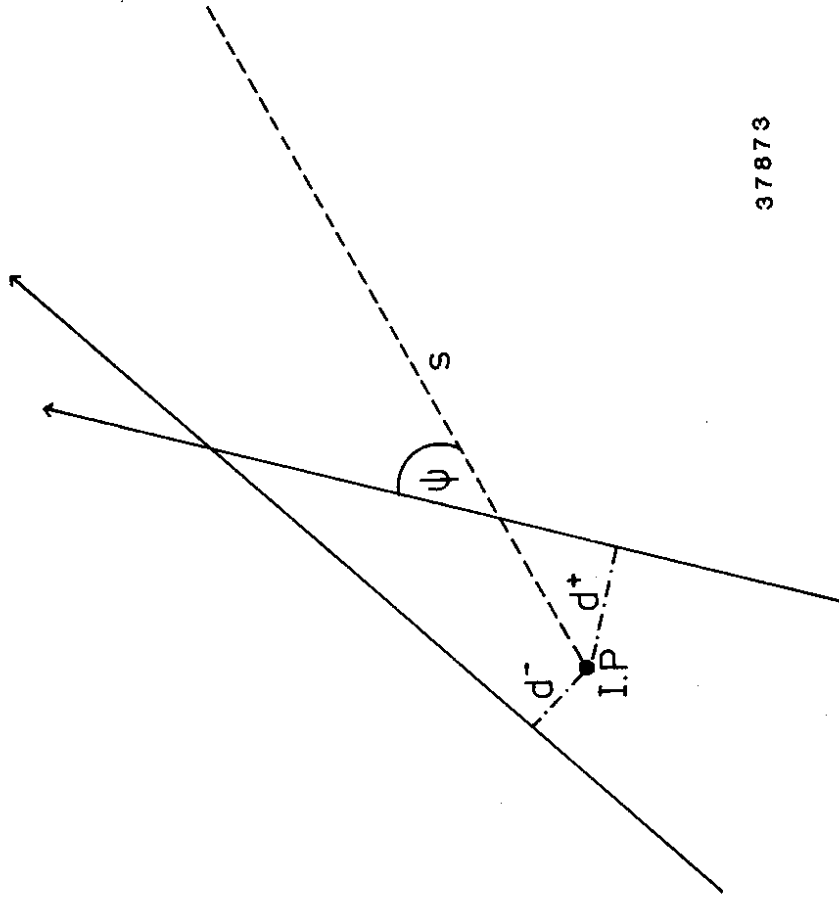

37873

Figure 5

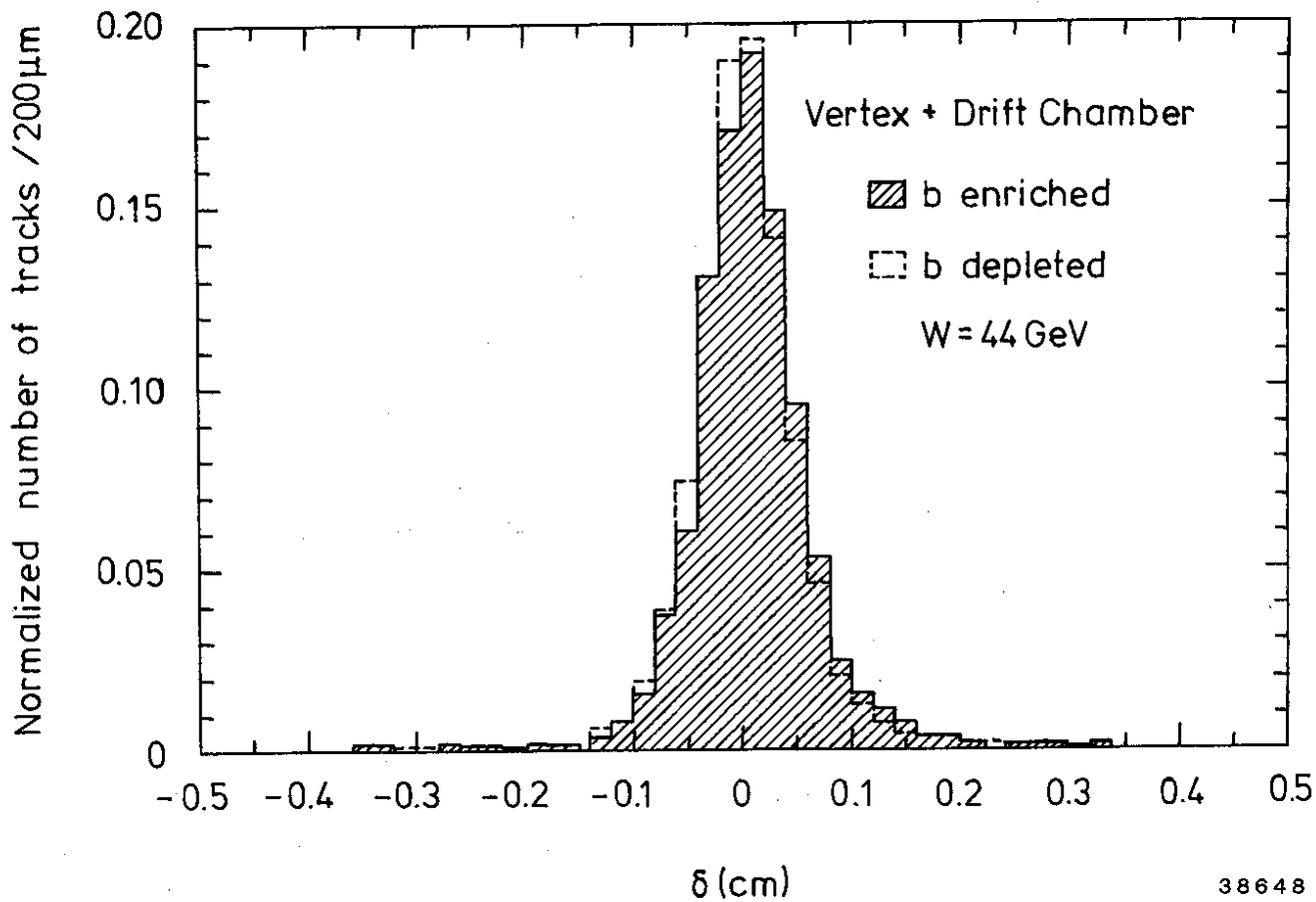

Figure 7

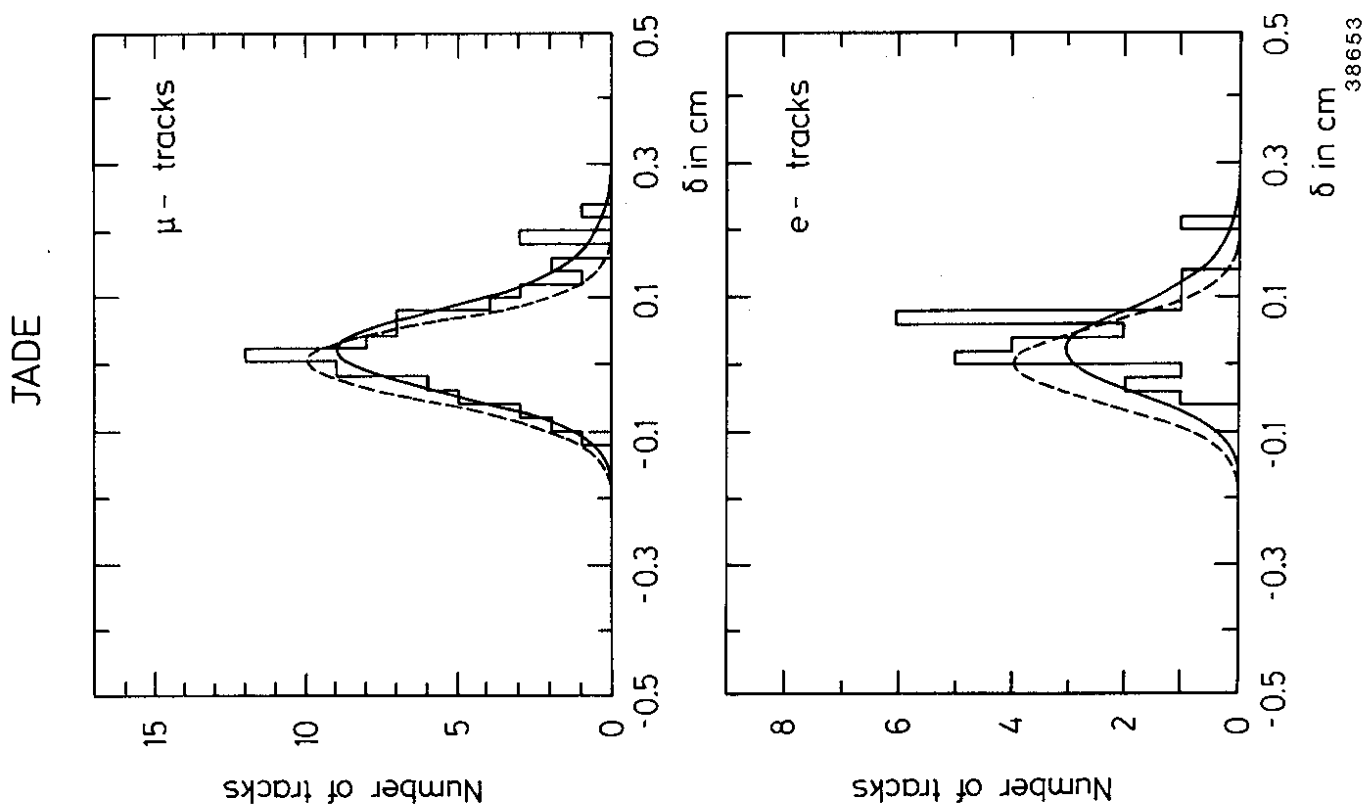

Figure 6

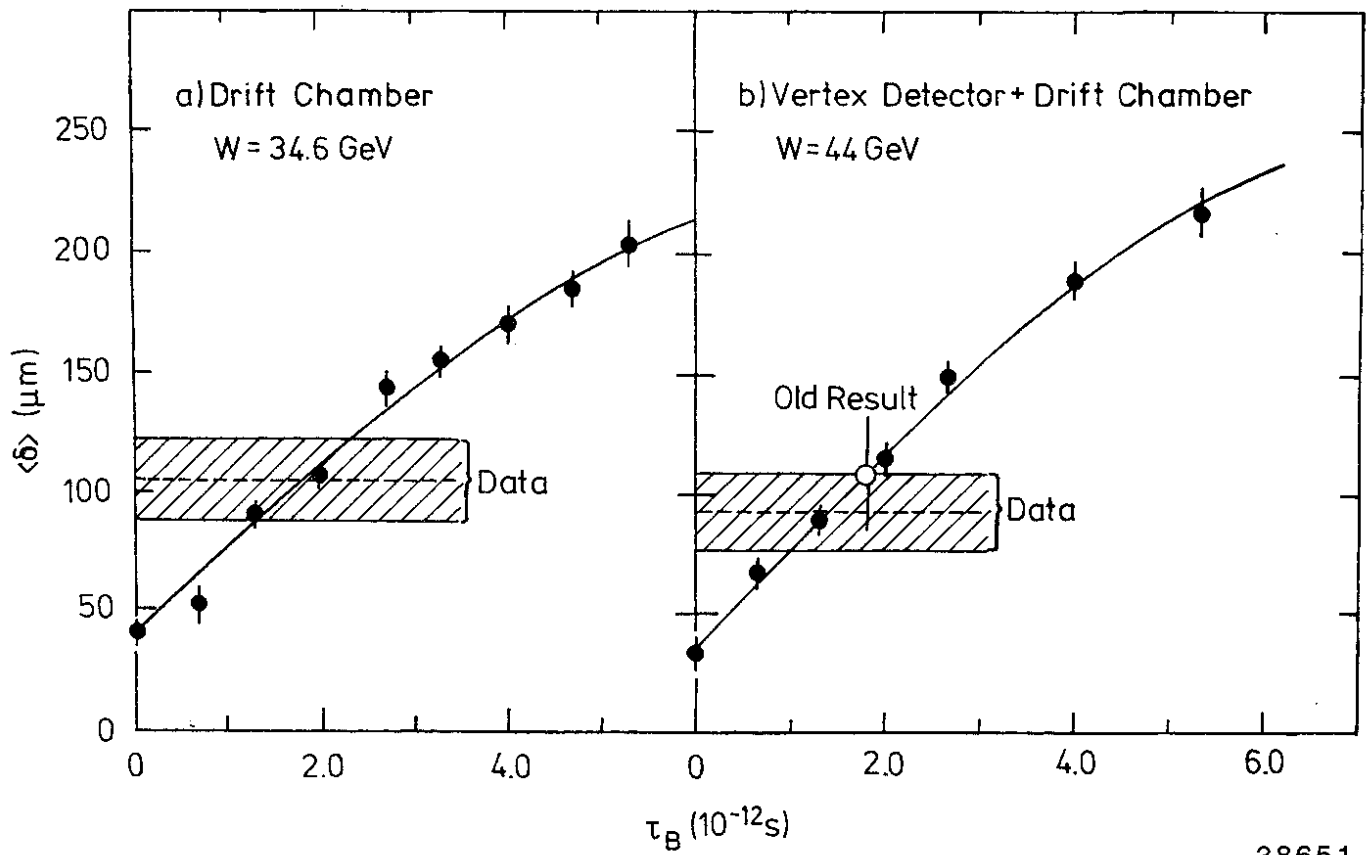

Figure 9

38651

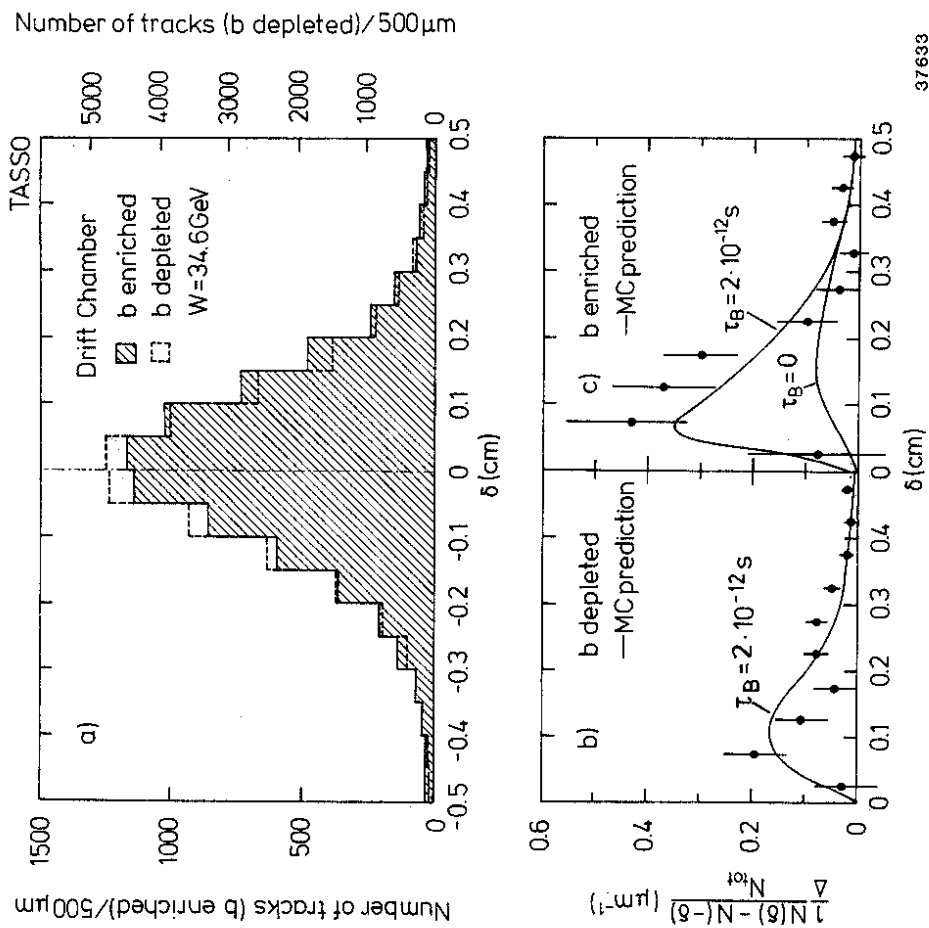
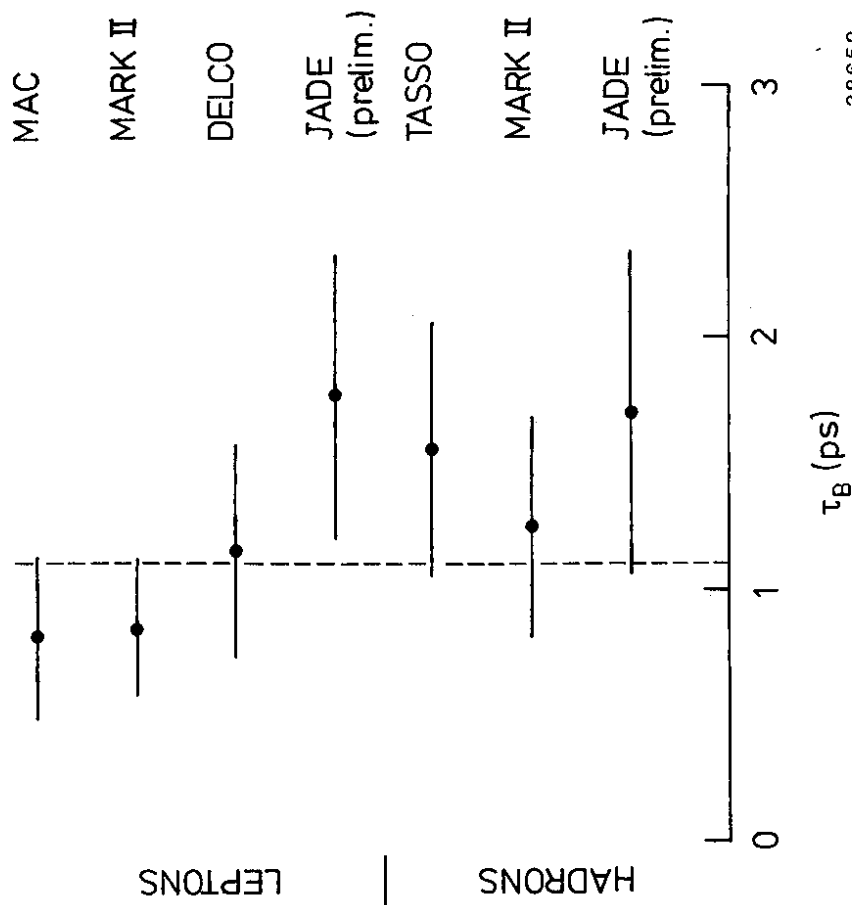

Figure 8



38652

Figure 10